

550 DaN

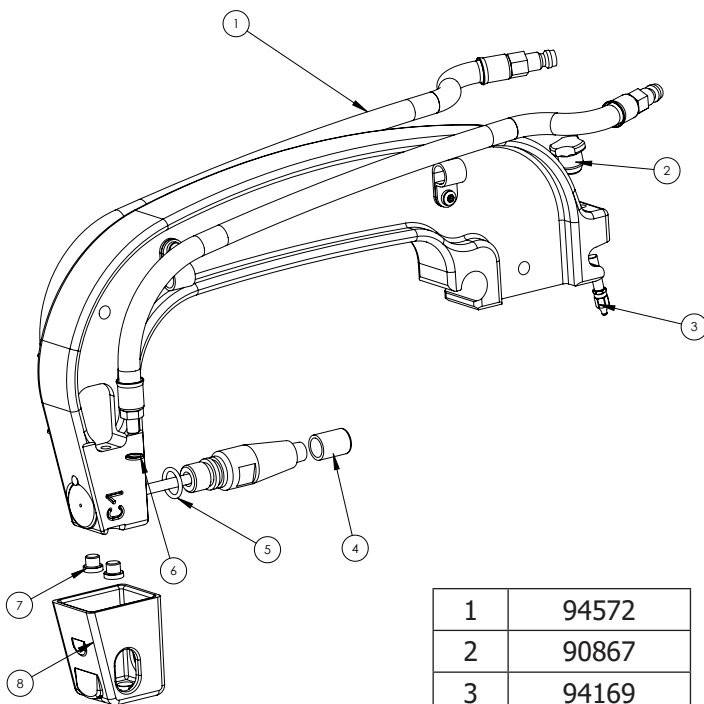

1	94572
2	90867
3	94169
4	77027
5	55121
6	71385
7	71716
8	56269

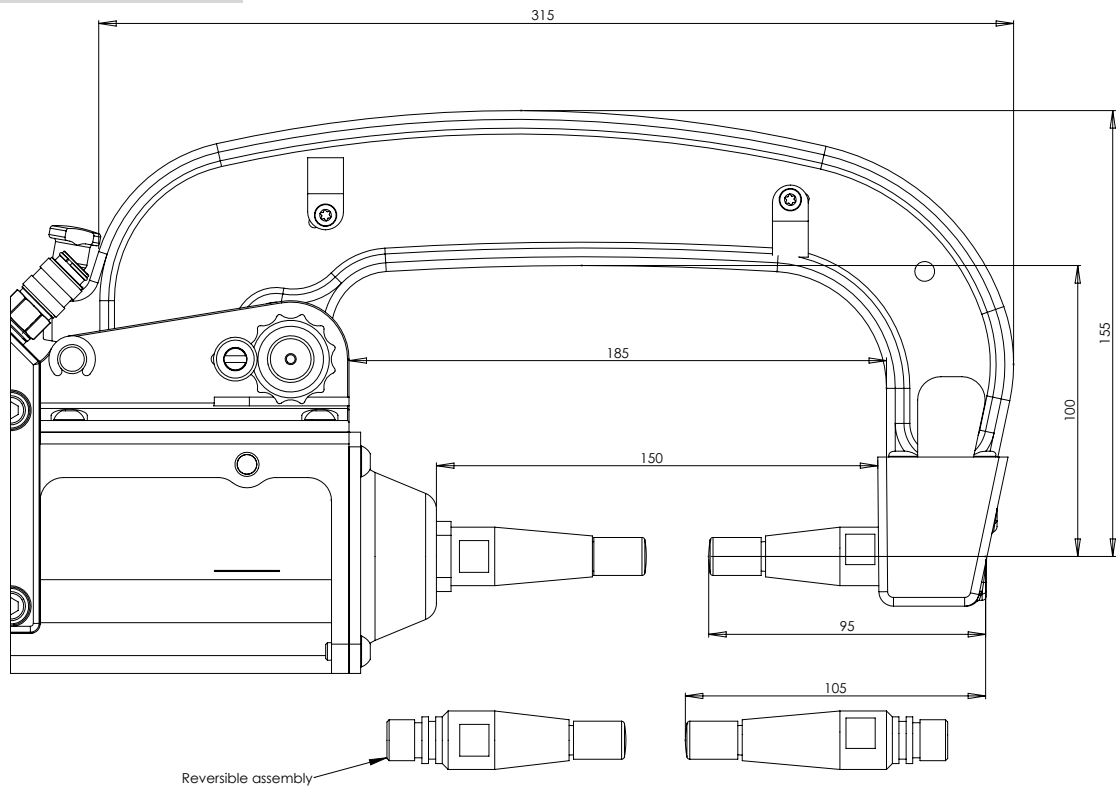

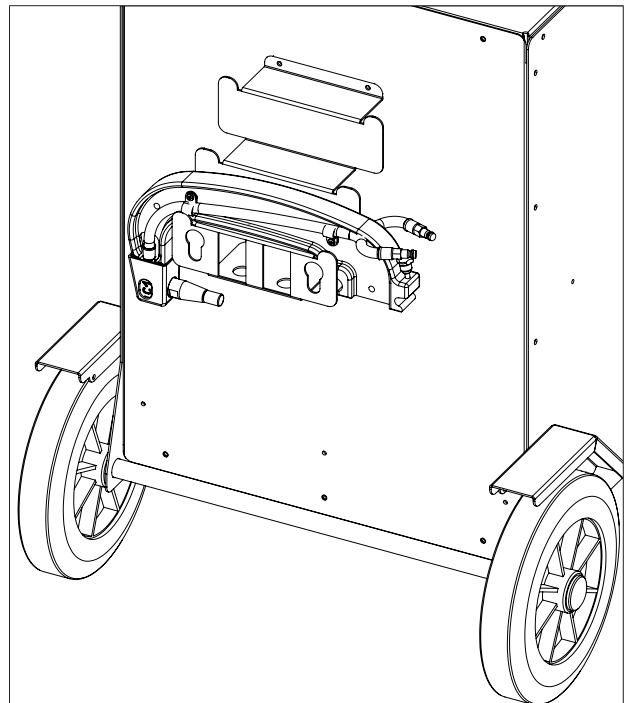
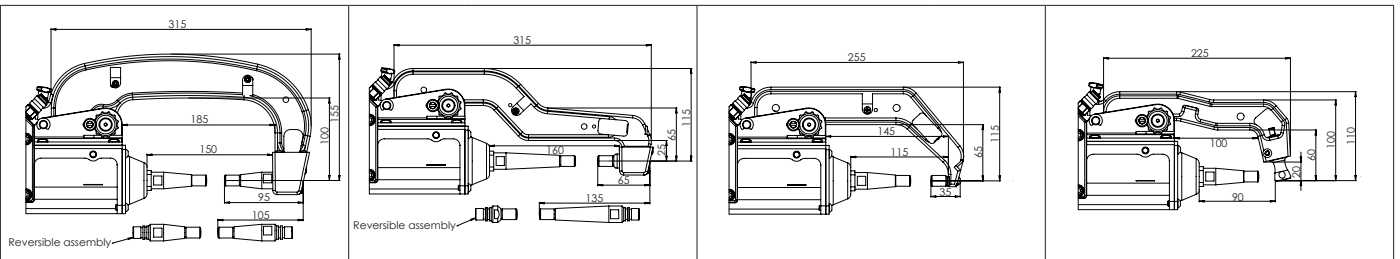

C1 - 021402
8 bar / 550 daN

C2 - 022386
8 bar / 550 daN

C5 - 022393
8 bar / 550 daN

C6 - 022409
8 bar / 300 daN

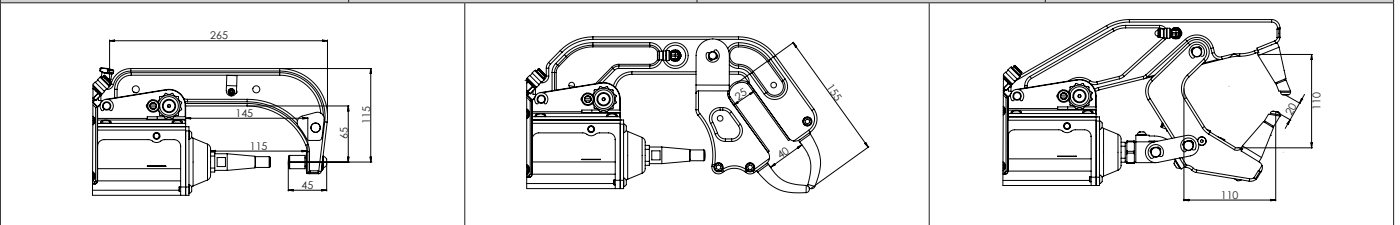

C12 - 022997
8 bar / 550 daN

C10 - 051638
4 bar / 150 daN

C11 - 053649
8 bar / 550 daN

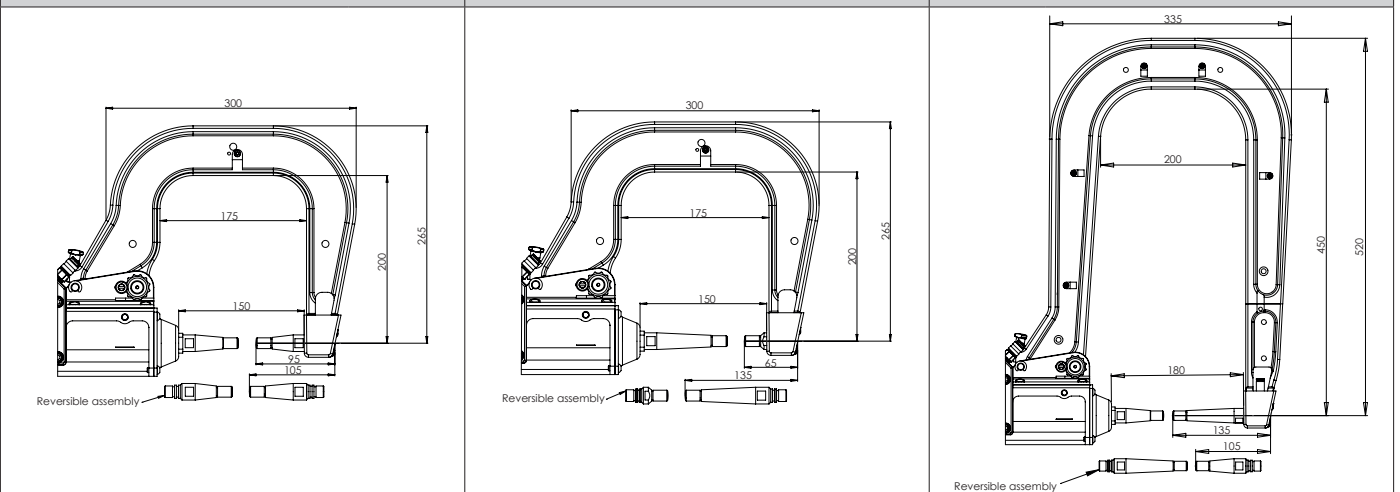

C3 - 021419
8 bar / 550 daN

C8 - 021440
8 bar / 550 daN

C4 - 021426
8 bar / 550 daN

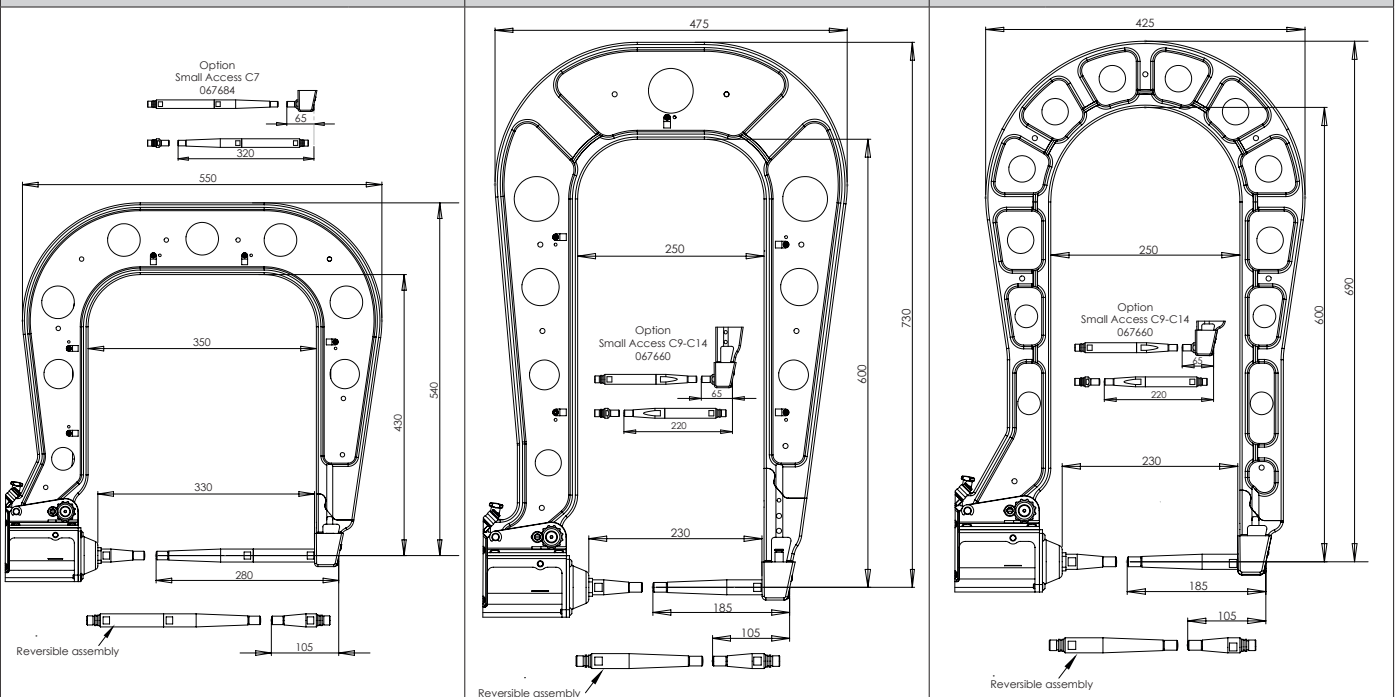

C7 - 021433
8 bar / 550 daN

C9 - 020078
8 bar / 550 daN

C14 - 023543
8 bar / 400 daN