

SPECIAL 20 WORLDWIDE 20

INDUSTRIAL + AUTOMOTIVE

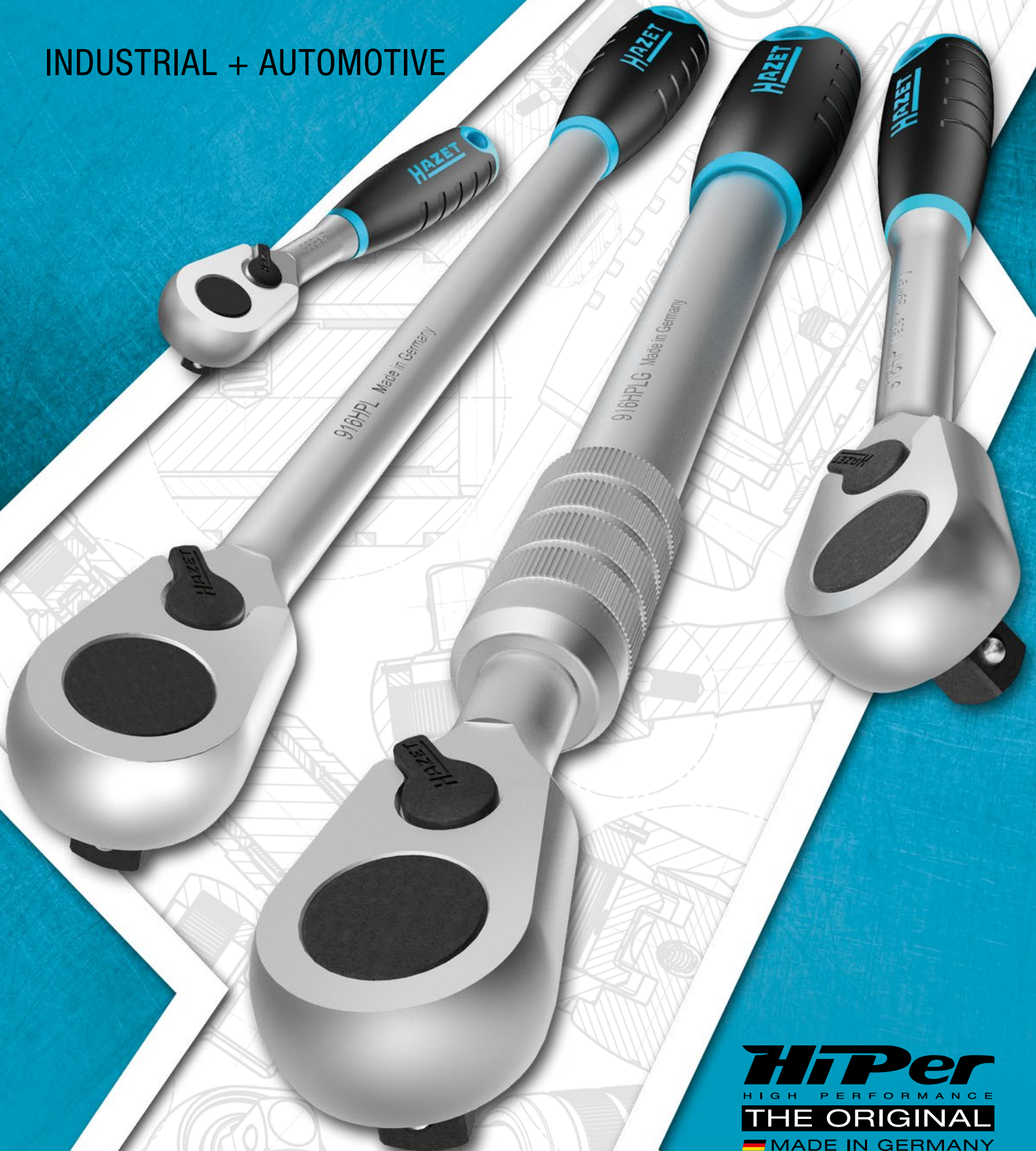

Das Werkzeug



HiPer
HIGH PERFORMANCE
THE ORIGINAL
MADE IN GERMANY

Valid until 28/02/2021

163-138/77 $\frac{1}{4}$ s 4-14 mm $\frac{1}{2}$ s 10-32 mm



163-374/27 s6-24 mm, s6x7-30x32 mm

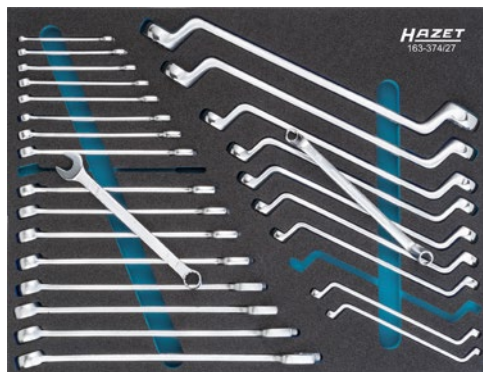

With plastic work surface
179 N-7/137
EAN-No. 4000896215270

137

With stainless steel work surface
179 N X-7/137
EAN-No. 4000896224463

137

163-141/31



Assistent[®]



Assortment



Including **HiPer**
12^s 1/2



Free!

5122-3CT
Made in Germany

3/3+		
------	--	--

Assortment



With plastic work surface
179 N-7/220
EAN-No. 4000896220267

220



+



3/3+		
------	--	--

Including **HiPer**
12^s 1/2

163-138/77 $\frac{1}{4}$ s 4-14 mm $\frac{1}{2}$ s 10-32 mm



163-140/33

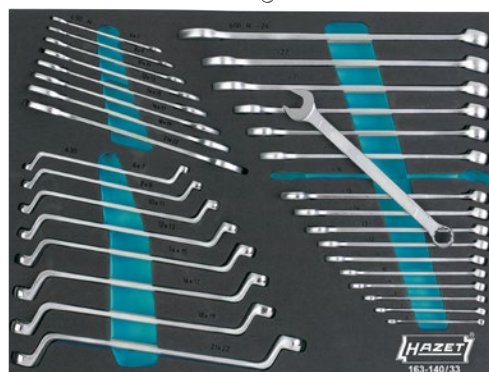

163-141/31



163-143/18



Tool trolley 179 N X-8/252 with 252 expert tools



Assistant®

Including
HiPer
125 1/2

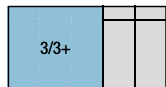

252

NEW!

179 N X-8
Made in Germany
L x W x H
785 x 518 x 1020 mm

With stainless steel
work surface

179 NX-8/252
EAN-No. 4000896232413

Assortment



163-369/104



163-372/25



163-526/41

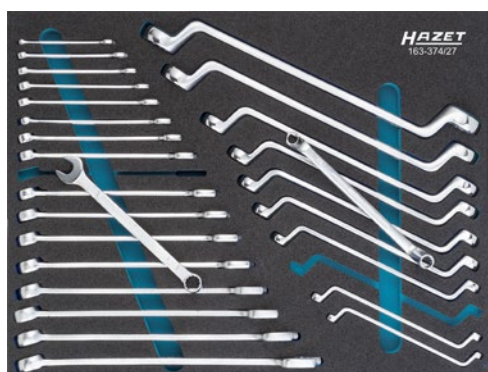

163-374/27 s6-24 mm,
s6x7-30x32 mm

163-172x50



163-515/16
6-24 mm

163-221/10
125 1/2 M8-M18

163-511/4



2128 N-1

Tool trolley without assortment

- Stainless steel or plastic work surface
- Overall loading capacity: 540 kg
- Drawer loading capacity: 25 kg each
- Drawer slide-out: 100%
- Dead weight: 90 kg
- Drawer internal dimensions: 522 x 398 mm

Made in Germany

HAZET No.	Work surface	Number of drawers	EAN-No. 4000896+
179 N-6	Plastic	6	214570
179 N-7	Plastic	7	214488
179 N-8	Plastic	8	214587
179 N X-6	Stainless steel	6	215560
179 N X-7	Stainless steel	7	215577
179 N X-8	Stainless steel	8	215584



PDF download
SWW 2020



Assistent®

265

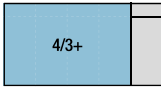

179 N XL-7
 Made in Germany
 L x W x H
 959 x 518 x 1020 mm

With stainless steel
work surface

179 N XL-7/265
 EAN-No. 4000896215201

Assortment



163-508/138

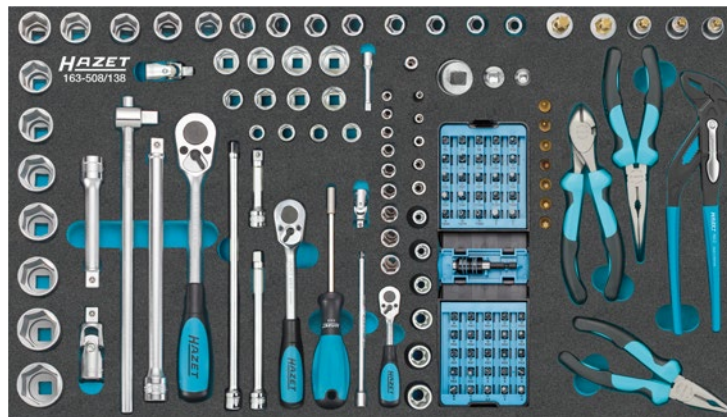

163-507/45

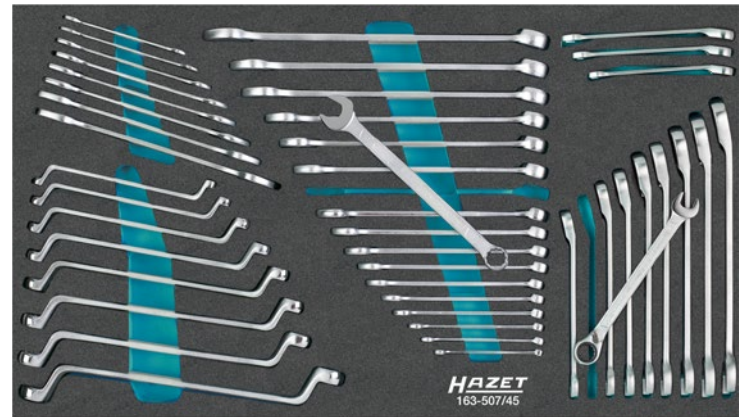

163-480/57



2128 N-1

Tool trolley without assortment

- Stainless steel work surface
- Overall loading capacity: 1000 kg
- Drawer loading capacity: 40 kg each
- Drawer slide-out: 100%
- Dead weight: 125 kg
- Drawer internal dimensions: 696 x 398 mm

Made in Germany

HAZET No.	Number of drawers	EAN-No. 4000896 +	
179 N XL-6	6	215171	
179 N XL-7	7	215164	
179 N XL-8	8	215218	



GERMAN
DESIGN
AWARD
WINNER
2019

179 NXL-6

Tool trolley 179 N XXL-8/378 with 378 expert tools



Assistent®

378

5/3+



179 N XXL-8
 Made in Germany
 L x W x H
 1133 x 518 x 1020 mm

Assortment



With stainless steel
work surface

179 N XXL-8/378

EAN-No. 4000896232390

163-172x50

163-481/194

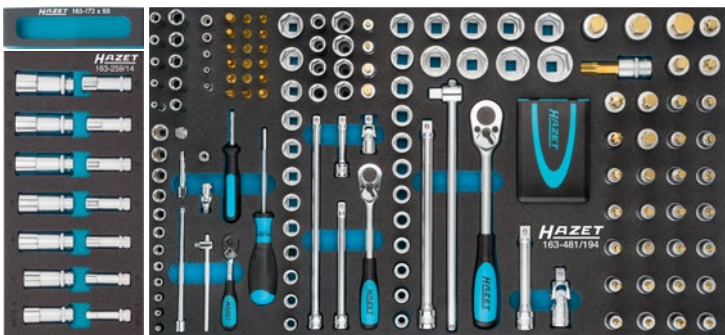

163-515/16

163-478/40



163-259/14

163-380/4

163-527/56



163-382/3

163-479/26



Tool trolley without assortment

- Stainless steel work surface
- Overall loading capacity: 1000 kg
- Drawer loading capacity: 40 kg each
- Drawer slide-out: 100%
- Dead weight: 145 kg
- Drawer internal dimensions: 870 x 398 mm

Made in Germany

HAZET No.	Number of drawers	EAN-No. 4000896+
179 N XXL-7	7	214624
179 N XXL-8	8	214778



179 N XXL-7



179 N XXL-8

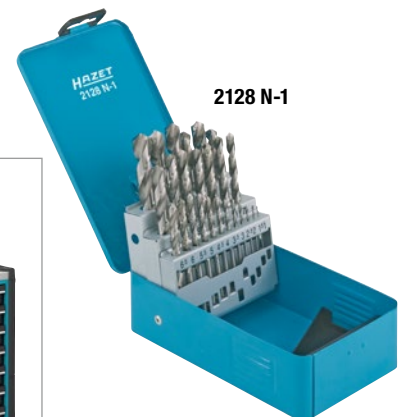

2128 N-1

Assistent®

3/3		
-----	--	--



2128 N-1



178 N-7
 Made in Germany
 L x W x H
 781 x 498 x 1037 mm

Assortment



178 N-7/204
 EAN-No. 4000896228072

163-329/100



163-30/25 s 6 – 24 mm, s 6x7 – 21x22 mm

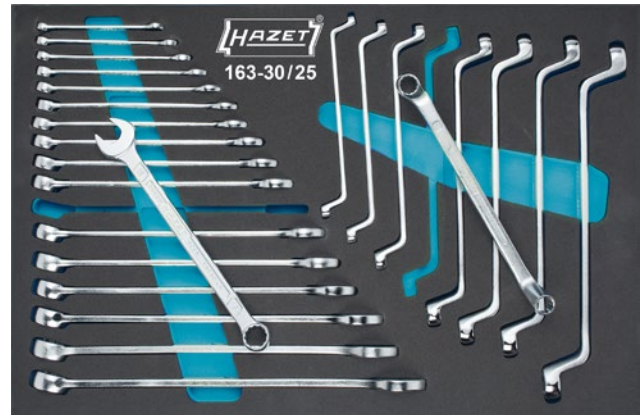

163-330/16 810-0,5x3,0–1,2x6,5 mm, 810 PH 1, PH 2
 810 T10–T30, 320 mm, 500 g



163-407/35 s 4–22 mm, M5–M18,
 M6–M14, T20–T60,

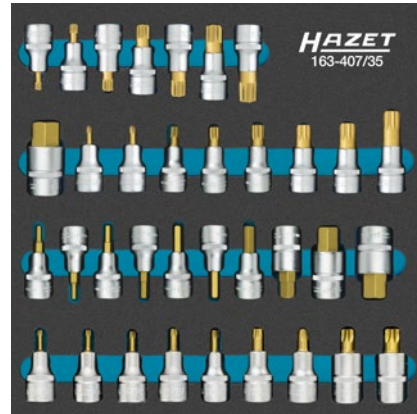

163-122/3 s 8, 10, 13 mm

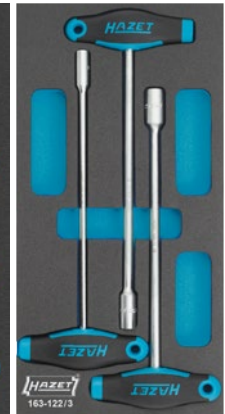

Tool trolley/tool chest without assortment

- Plastic work surface
- Overall loading capacity: 480 kg
- Drawer loading capacity: 20 kg each
- Drawer slide-out: 100%
- Dead weight: trolley 74.1 kg / tool chest 33.7 kg

Made in Germany

HAZET No.	Number of drawers	EAN-No. 4000896 +	
178 N-7	7	202782	
178 N-10	10	202805	
178 NK-3	3	202799	



178 N-7



178 N-10
 L x W x H
 781 x 498 x 1410 mm



178 NK-3
 L x W x H
 696 x 488 x 390 mm

Work bench 179 NW-7/230 with 230 expert tools



Assistant®

230

3/3+		
------	--	--



179 NW-7
Made in Germany
 L x W x H
 1150 x 600 x 965 mm

Assortment



179 NW-7/230
 EAN-No. 4000896219605



163-513/122

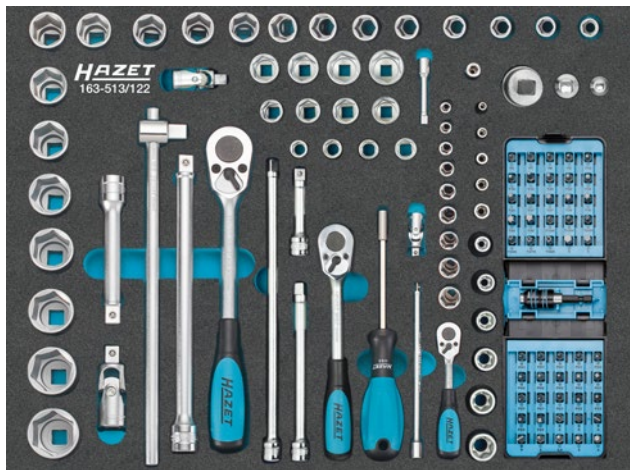

163-526/41



163-525/40

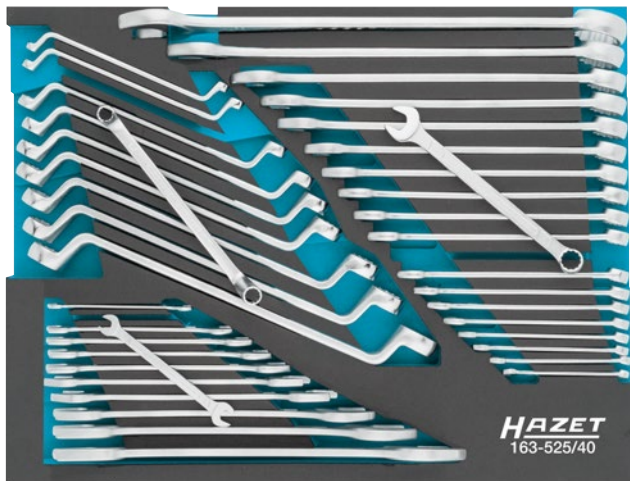

163-372/25



Work bench without assortment

- Wood multiplex birch work surface
- Overall loading capacity: 750 kg
- Drawer loading capacity: 25 kg each, bottom drawer 40 kg
- Dead weight: 120 kg

Made in Germany

HAZET No.	Number of drawers	EAN-No. 4000896+	
179 NW-7	7	219629	



- Includes fixed mounted door. Only one lock for door and drawers
- Flexible vice assembly (front, right, left) e.g. HAZET 2175 N according to drilling template specification
- Cable duct on rear panel allows battery devices to be charged when the door is closed, for instance



Tool trolley

- Pillars can swing down to minimum height for space saving transport

3/3		
-----	--	--

166 N



Service trolley

- Rectangular perforation on the side panels offer individual fastening options

Suitable for two 3/3+ inserts per tray

3/3+		
------	--	--

167-3S



Service trolley

- Flexible and stable for all purposes
- More trays and anti-slipping mats are optionally available

Suitable for two 3/3+ inserts per tray

3/3+		
------	--	--

167-3



Multi Table

- Fits under vehicles with a ground clearance greater than 130 mm
- Extensive accessories available

3/3+		
------	--	--

167 T



Made in Germany

HAZET No.	Designation	H x W x D mm	Loading weight kg	kg	EAN-No. 4000896+
166 N	Tool trolley	965 x 680 x 350	300	24.5	004959
167-3S	Service trolley	899 x 888 x 541	50 (per tray)	27	207206
167-3	Service trolley	899 x 890 x 542	50 (per tray)	25.4	205332
167 T	Multi Table	950-1300 x 740 x 750	35 (table)	17.9	210503

Assistent[®]

Tool trolley | Work bench accessories

New tool modules



HAZET No.	Designation	EAN-No. 4000896 +
179-45	Adapter for tray holder 179 N-45	224005
179 N-45	Tray holder	224210
179 N-35	Can holder	224258
179 N-46	Impact wrench holder	224265
179 NW-11	Machinist's vice fastening set	221967
179 N-42	Laptop holder for 179 N, 179 N X, 179 N XL, 179 N XXL	215621
179-35	Can holder	141074
180-24	Document holder	110827
179 N-21	Side door for 179 N, 179 N X, 179 N XL, 179 N XXL	215553
180-33	Paper bin	120833
179-28	Tool bin	141234
180-34	Holder for paper reel	120840
179 N-19	Small parts collector	214457
179 N-26	Perforated tool panel for 179 N, 179 N X	215522
179 N XL-26	Perforated tool panel for 179 N XL	215539
179 N XXL-26	Perforated tool panel for 179 N XXL	215546



More information in the 2020 tool catalogue from page 47

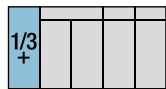

The extensive selection of tool modules in the 2020 Tool Catalogue, from page 85

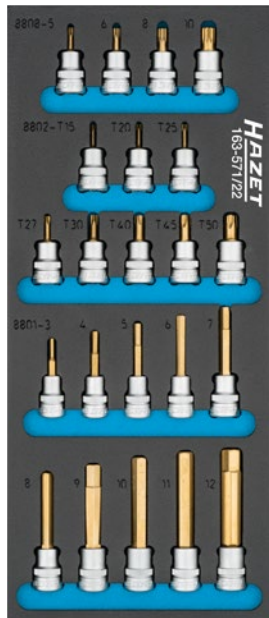

22 **TIN** **NEW!**

10 3/8" ○ ○ ○

Screwdriver socket set TIN

- 8801-3, -4, -5, -6, -7, -8, -9, -10, -11, -12
- 8808- 5, -6, -8, -10
- 8802-T15, -T20, -T25, -T27, -T30, -T40, -T45, -T50

Made in Germany

163-571/22

EAN-No. 4000896233434



24 **NEW!**

12 1/2" ○ ○

Impact (screwdriver) socket set

- 900 SZ6-19, -21, -22, -24, -27, -30, -32, -36
- 985 S-14, -17, -19
- 985 S-14 Lg, -17 Lg, -19 Lg
- 990 S-14, -16, -18
- 990 S-14 Lg, -16 Lg, -18 Lg
- 12 1/2" 20 3/4" 1007 S-7/4

Made in Germany

163-570/24

EAN-No. 4000896233441

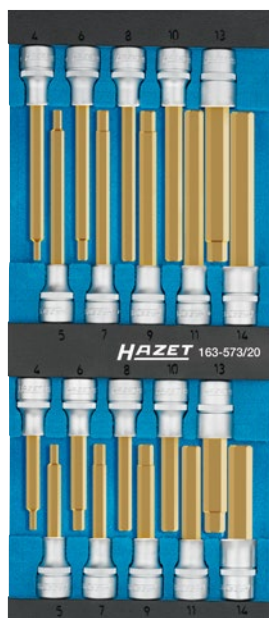
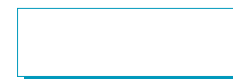

20 **TIN** **NEW!**

12 1/2" ○

Screwdriver socket set TIN

- 986 L-4, -5, -6, -7, -8, -9, -10, -11, -12, -14
Length: 100 mm
- 986 SL-4, -5, -6, -7, -8, -9, -10, -11, -12, -14
Length: 140 mm

Components see page 15

Made in Germany

163-573/20

EAN-No. 4000896232871

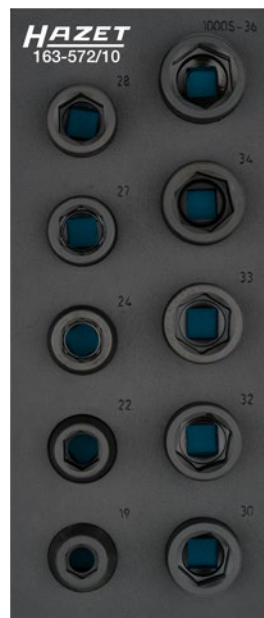

10 **NEW!**

20 3/4" ○

Impact socket set

- 1000 S-19, -22, -24, -27, -28, -30, -32, -33, -34, -36

Made in Germany

163-572/10

EAN-No. 4000896233236



HiPer

HIGH PERFORMANCE

THE ORIGINAL

MADE IN GERMANY

Static AND dynamic – Double precision in perfection!

NEW!

916 HPLG

 12⁵ 1/2

Continuously adjustable fine-tooth reversible ratchet from 414 to 614 mm!

- ▶ Easy fixation with knurled clamping nut
- ▶ Continuously adjustable – no pre-fixed detent points
- ▶ Twist protected handle ensures optimum force transmission without slipping

 12⁵ 1/2

Performance comparison

Peak load

DIN 3122:2017-04 (static load)

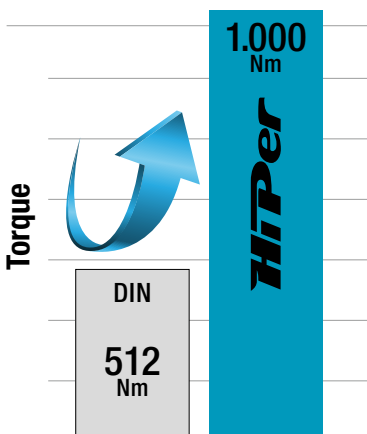
 12⁵ 1/2 916 HPLG** / 916 HPL / 916 HP

6.3 1/4 863 HP

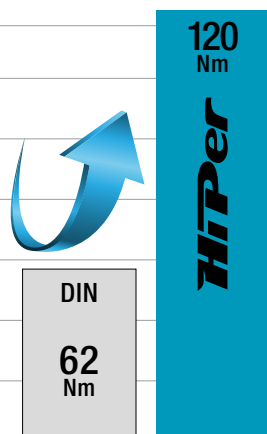

Durability | Permanent load

ISO 3315:2018-05 (dynamic load)

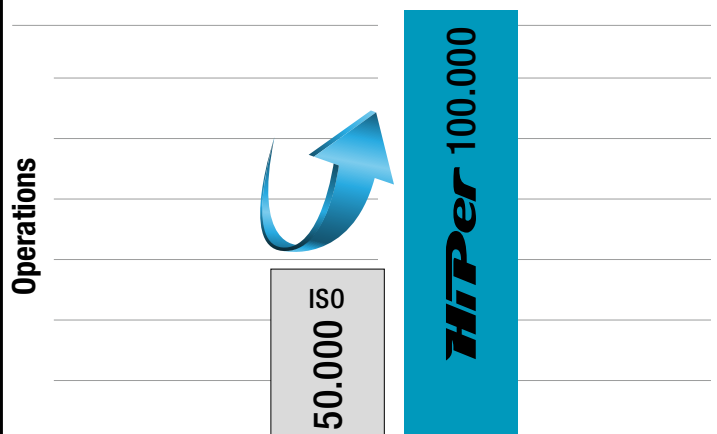
 12⁵ 1/2 916 HPLG** / 916 HPL / 916 HP 6.3 1/4 863 HP

** Delivered packed together

6.3 1/4 12^S 1/2

Fine-tooth reversible ratchets

- ▶ Developed and manufactured „Made in Germany“
- ▶ Peak load: 12^S 1/2 1,000 Nm | 6.3 1/4 120 Nm
- ▶ High permanent load for durability
- ▶ 90 teeth, 4° fine toothed for confined spaces
- ▶ Engaging function of the shift lever provides protection against unwanted switching
- ▶ A lot more power with the same dimensions
- ▶ Strict production tolerances ensure protection against penetration by dirt

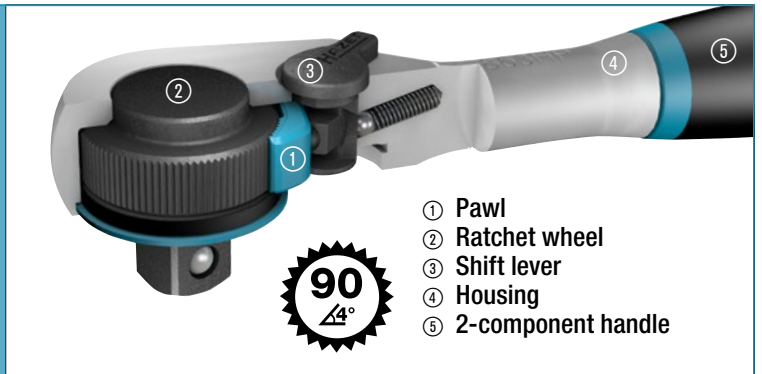

- ① Pawl
- ② Ratchet wheel
- ③ Shift lever
- ④ Housing
- ⑤ 2-component handle



Ergonomic shift lever



Integrated suspension option in the handle



Made in Germany
916 HPLG
EAN-No. 4000896233076



l
mm
max.
614

1.000 Nm



Made in Germany
916 HPL
EAN-No. 4000896219209



l
mm
415

1.000 Nm



Made in Germany
916 HP
EAN-No. 4000896213894



l
mm
275

1.000 Nm

12^S 1/2



Made in Germany
863 HP
EAN-No. 4000896226917

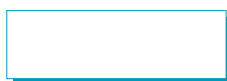

l
mm
116

120 Nm

6.3 1/4



916 HP

Strongest HAZET ratchet!

6.3 1/4

916 HPLG / 916 HPL / 916 HP



863 HP



Socket set

6.3 1/4 12.5 1/2 6.3 1/4 12.5 1/2 6.3 1/4 47

Including
HiPer
6.3 1/4 12.5 1/2

1/3			
-----	--	--	--



1 x		12.5 1/2	916 HP HiPer 1000 Nm
14 x		12.5 1/2	10 · 11 · 12 · 13 · 14 · 15 · 16 17 · 18 · 19 · 21 · 22 · 24 · 27 mm
2 x		12.5 1/2 12.5 1/2	123 · 248 mm
1 x		6.3 1/4	863 HP HiPer 120 Nm
9 x		6.3 1/4	5 · 6 · 7 · 8 · 9 · 10 · 11 · 12 · 13 mm
1 x		6.3 1/4 6.3 1/4	100 mm
1 x			□ 6.3 = 1/4" ○ 6.3 = 1/4"
1 x			866 U
3 x			0.5 x 4 · 0.6 x 4.5 · 0.8 x 5.5 mm
2 x			PH 1 · PH 2
2 x			PZ 1 · PZ 2
5 x			s 2 · 3 · 4 · 5 · 6 mm
5 x			T 10 · T 15 · T 20 · T 25 · T 30

Made in Germany
953 HP
EAN-No. 4000896215188

Adapter set

• With locking ball

7

20 3/4 20 3/4
12.5 1/2 12.5 1/2
10 3/8 10 3/8
6.3 1/4 6.3 1/4
6.3 1/4



Made in Germany
958/7
EAN-No. 4000896204595

Screwdriver socket set with TIN coated blades

12.5 1/2



9 **TORX®**
TIN 12.5 1/2

1/9			
-----	--	--	--

With SmartCase (1/9)
L x W x H
185 x 153 x 52 mm



Made in Germany

HAZET No.	Contents	kg	EAN-No. 4000896 +
986/9 N	s 5, 6, 7, 8, 9, 10, 12, 14, 17 mm	1.27	193530

Made in Germany

HAZET No.	Contents	kg	EAN-No. 4000896 +
992/9	T20, T25, T27, T30, T40, T45, T50, T55, T60	1.41	051540

Sanitation set Combination wrench / Pliers



Sanitation / Heating tool set



- Compact, special tool set for the areas of sanitation, heating, air-conditioning and solar installations
- Operating tools designed for use in narrow and low-lying work areas
- Safe working in high-voltage areas thanks to tested VDE tools (up to 1000 V)

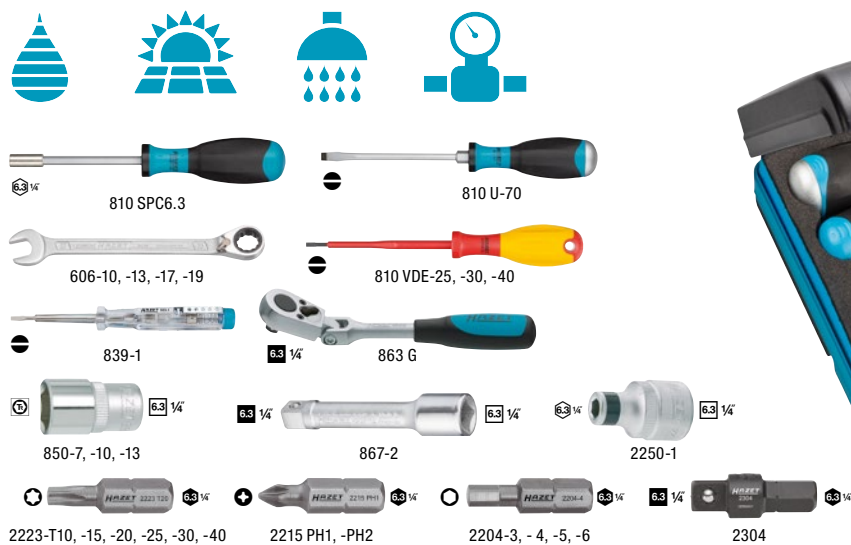

Combination wrench sets



Combination wrench, extra long, slim design



Made in Germany

HAZET No.	Contents	■	EAN-No. 4000896+
600 SPC/10	s 8, 10, 12, 13, 14, 15, 16, 17, 18, 19 mm	10	118465
600 SPC/16	s 7, 8, 9, 11, 10, 12, 13, 14, 15, 16, 17, 18, 19, 21, 22, 24 mm	16	186235
600 Lg/10	s 10, 11, 12, 13, 14, 15, 16, 17, 18, 19 mm	10	218424
600 Lg/13	s 10, 11, 12, 13, 14, 15, 16, 17, 18, 19, 21, 22, 24 mm	13	218417



Universal pliers with quick-adjust lever

- Comfortable quick adjustment thanks to tip/step lever function
- Adjustment without re-gripping – one-hand actuation possible



Made in Germany

HAZET No.	Description	l mm	EAN-No. 4000896+
760-2	Universal pliers for right-handed people	260	188451
760 L-2	Universal pliers for left-handed people	260	191291

Pliers set



Made in Germany

HAZET No.	l mm	EAN-No. 4000896+
1859 SPC/3	250, 165, 160	179039

Slot



810S/6

EAN-No. 4000896224166



3x		810	0.8x4.0 · 1.0x5.5 · 1.2x6.5 mm
3x		810 U	0.8x4.5 · 1.0x5.5 · 1.2x7 mm



Slot / Phillips



810/6

EAN-No. 4000896058808



4x		810	0.5x3.0 · 0.8x4.0 · 1.0x5.5 · 1.2x6.5 mm
2x		PH1 · PH2	



Pozidriv / Slot



810/6 PZ

EAN-No. 4000896217984



4x		810	0.5x3.0 · 0.8x4.0 · 1.0x5.5 · 1.2x6.5 mm
2x		PZ 1 · PZ 2	



TORX®



810 T/6

EAN-No. 4000896204304



6x		T10 · T15 · T20 · T25 · T27 · T30	
----	--	-----------------------------------	--



Impact cap



810 U-1/5

EAN-No. 4000896179572



3x		810	0.8x4.5 · 1.0x5.5 · 1.2x7 mm
2x		PH1 · PH2	



HEXAnamic®



802/5

EAN-No. 4000896147359



3x		802	0.8x4.0 · 1.0x5.5 · 1.2x6.5 mm
2x		PH1 · PH2	



Offset screwdriver | Screwdriver sockets



Offset screwdriver

- With ergonomically shaped 2-component T-handle with lateral blade
- Efficient and flexible use under different accessibility conditions
- Surface: chrome-plated, tip burnished
- With ball-head

Available in April 2020

NEW!

• For inside hexagon screws

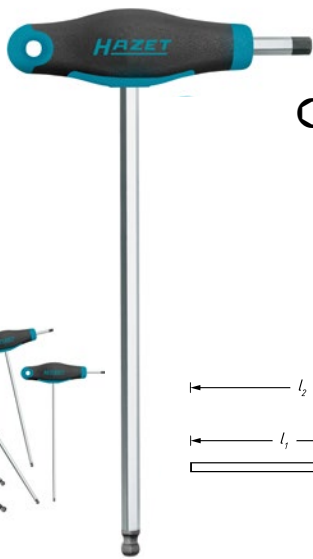

829 KK/7

EAN-No. 4000896232888



HAZET No.	S mm	l ₁ mm	l ₂ mm	l ₃ mm	EAN-No. 4000896+
829 KK-2	2	100	118	15	232895
829 KK-2.5	2.5	100	118	15	232901
829 KK-3	3	150	168	15	232918
829 KK-4	4	150	176	20	232925
829 KK-5	5	200	176	20	233038
829 KK-6	6	200	234	25	233045
829 KK-8	8	200	234	25	233052

• For inside TORX® screws



829 KKT/7

EAN-No. 4000896233014



HAZET No.	S mm	l ₁ mm	l ₂ mm	l ₃ mm	EAN-No. 4000896+
829 KKT-T9	9	80	98	15	233069
829 KKT-T10	10	80	98	15	233137
829 KKT-T15	15	100	126	20	233144
829 KKT-T20	20	100	126	20	233168
829 KKT-T25	25	110	136	20	233175
829 KKT-T30	30	130	156	20	233182
829 KKT-T40	40	130	164	25	233199

Screwdriver socket

- Long design
- With knurling
- DIN 7422

TIN

NEW!

986 L

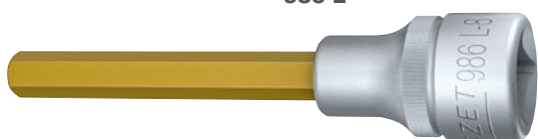

Screwdriver socket

- Extra long pattern
- With knurling
- DIN 7422

TIN

NEW!

986 SL



Made in Germany

HAZET No.	S mm	l ₁ mm	l ₂ mm	d mm	EAN-No. 4000896+
986 L-4	4	62	100	23	232635
986 L-5	5				232628
986 L-6	6				232611
986 L-7	7				232604
986 L-8	8				232598
986 L-9	9				232581
986 L-10	10				232574
986 L-11	11				232567
986 L-12	12				232550
986 L-14	14				232543

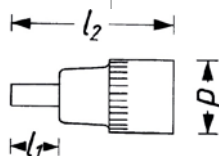
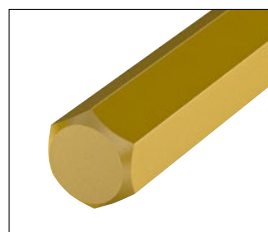

Made in Germany

HAZET No.	S mm	l ₁ mm	l ₂ mm	d mm	EAN-No. 4000896+
986 SL-4	4	102	140	23	232291
986 SL-5	5				232376
986 SL-6	6				232369
986 SL-7	7				232352
986 SL-8	8				232345
986 SL-9	9				232338
986 SL-10	10				232321
986 SL-11	11				232314
986 SL-12	12				232536
986 SL-14	14				232307

1003 S-1

One power adapter – many possibilities!

For loosening 1/2" bolted joints with 3/4" power!

For all sockets with outside hexagon 24

900 SZ6 / 990 S / 985 S



1/2" S 24 mm



Take, for example, our 3/4" impact wrench 9013 M and connect our adapter 1003 S-1 to the square. At the other end, put one of our sockets with outside hexagon connection.

Adapter with borehole for locking pin or safety spring and groove for o-ring

12-point profile

12⁵ 1/2 20 3/4 24 11



HAZET No.	l mm	d ₁ mm	t mm	EAN-No. 4000896+
900 SZ6-19	40	30.5	11.6	225293
900 SZ6-21	40	32.5	11.7	225309
900 SZ6-22	40	32.5	11.7	225316
900 SZ6-24	44	36	17.5	225323
900 SZ6-27	45	40	17.9	225330
900 SZ6-30	50	43	23.3	225347
900 SZ6-32	50	45	22.2	225354
900 SZ6-36	60	53	25	225361

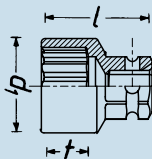

- Short design
- Surface: phosphatized, oiled
- In 2-component soft foam insert



Made in Germany

900 SZ6/11

EAN-No. 4000896225378

12-point profile

12⁵ 1/2 4

- For the operation of screwed connections on drive shafts and cardan shafts
- s 24 mm for VW Touran since 2006 and Passat C
- s 30 mm for the axle shaft nut on VW Golf 4, Polo, New Beetle, AUDI TT 1.8, ŠKODA Octavia, Superb, Fabia
- s 32 mm for the operation of screwed connections on cardan shafts in the wheel hub on VW Touareg since 2003
- s 36 for the axle shaft nut on BMW 3, 5 and 7 Series, Z3, M3, VW Polo since 2001, Golf Plus 1.8 TDI since 2005, SEAT Ibiza since 2002



Made in Germany

900 SZ/4

EAN-No. 4000896156375

Impact screwdriver sockets

Made in Germany



XZN profile

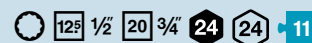

Made in Germany

990 S/11

EAN-No. 4000896162406

- Screw connections on commercial vehicles and passenger cars with XZN profile e.g. on chassis, brake system (brake carriers), engines, shock absorbers and camshaft sprocket
- Wrench sizes $\leq 14, 16$ and 18 mm
- In 2-component soft foam insert

Hexagon profile



Made in Germany

985 S/11

EAN-No. 4000896211951

- For screw connections on commercial vehicles and cars, e.g. on chassis, brake system (brake carriers), engines and shock absorbers
- Wrench sizes $\leq 14, 17$ and 19 mm
- In 2-component soft foam insert

Supplements 985 S/11

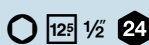

- Drive optionally $\frac{1}{2}$ or outside hexagon ≤ 24 mm
- Can also be used with HAZET adapter 1003S-1 with $\frac{3}{4}$ for transmission of high release forces
- For screw connections on commercial vehicles and cars e.g. on chassis, brake systems (brake carriers) and engines

Adapter

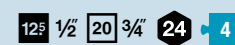

- With replaceable $\frac{1}{2}$ impact insert adapter
- The enormous force of the $\frac{3}{4}$ drive results in high load on and increased wear of the $\frac{1}{2}$ output. The hexagon adaptation means the $\frac{1}{2}$ output is replaceable, thereby making the adapter more versatile!



Made in Germany

HAZET No.	S mm	l ₁ mm	l ₂ mm	EAN-No. 4000896 +
985 S-22	22	20.5	45	218219
985 S-24	24	-	45	218226

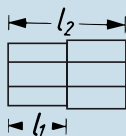

Made in Germany

1007 S-7/4

EAN-No. 4000896215416

Hexagon profile

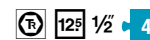

- Particularly suitable together with short impact wrenches e.g. HAZET 9012 M and 9012 MT
- Surface: phosphatized, oiled
- Wrench sizes $\leq 13, 17, 19$ and 21 mm

Extra short!



Made in Germany

900 SK/4

EAN-No. 4000896201785



Splitting tools

- Easy penetration into the wood due to specially polished cutting edge (lamella grinding technique)
- Very good hold / grip due to particularly ergonomically shaped handle with non-slip special grip end

NEW!

Original USA hickory wooden handle!



2132-600

Made in Germany

Hand axe, 600 g

- Universal application in gardening and forestry work
- Handy helper, especially suitable for splitting firewood and cutting off small branches
- Tool head and tool handle with **double** safety wedging



2133-1250

Made in Germany

Wood axe, 1250 g

- Highly suitable for delimiting trunks, splitting firewood up to 20 cm Ø and felling smaller trees
- To increase service life, the handle is specially protected by an impact protection sleeve in case of failure
- Tool head and tool handle with **triple** safety wedging



2134-1250

Made in Germany

Riving axe, 1250 g

- For splitting firewood up to 20 cm Ø
- Cutting edge penetrates the wood quickly and easily and the wide tool head effectively pushes the wood apart
- High splitting effect due to special tool head shape with hollow forged spreading wedges. Spreading wedges prevent the axe from jamming in the wood
- To increase service life, the handle is specially protected by an impact protection sleeve in case of failure
- Tool head and tool handle with **triple** safety wedging



2135-3000

Made in Germany

Sledgehammer, 3000 g

- For splitting firewood above 35 cm Ø
- Very well suited for tearing up metre-long pieces and driving aluminium wedges into wood
- Forged turning tappet to easily pull or turn pieces of wood
- To increase service life, the handle is specially protected by an impact protection sleeve in case of failure
- Tool head and tool handle with **triple** safety wedging



2157-3

Jack-knife with blade lock

- Flexible use in the workshop, industry, warehouse or hobby sector
- The blade lock protects against injury when in the opened position, the knife is prevented from snapping shut unexpectedly
- Ergonomic aluminium grip thanks to moulded handle
- High-quality stainless steel blade
- Light, handy design with practical belt clip

HAZET No.	Designation	l mm	EAN-No. 4000896 +
2132-600	Hand axe, 600 g	360 (Handle length)	231140
2133-1250	Wood axe, 1250 g	700 (Handle length)	231133
2134-1250	Riving axe, 1250 g	500 (Handle length)	229529
2135-3000	Sledgehammer, 3000 g	900 (Handle length)	231157
2157-3	Jack-knife with blade lock	115 (folded)	231089

Plastic hammer

 **Made in Germany**



Non-rebound!



Filling of the T-head with metal balls ensures no rebound when striking. Full impact force is transferred to the workpiece

Fatigue-free, low-noise and joint-friendly working



Simply the best!

NEW!

Completely welded hammer with durable powder coating

Ergonomically shaped, non-slip handle made of shatterproof tubular steel

Impact inserts made from special nylon for very high impact force (replaceable) – no chipping

Quality guarantee  **Made in Germany**



Plastic hammer

- **Non-rebound:** due to steel ball filling in the centre part of the hammer head and the special material of impact caps
- Replaceable hammer heads made of polyurethane, non-spalling and non-crumbing
- Gentle and careful working
- Abrasion-proof, long service-life
- PVC handle, resistant to oil and gasoline



Spare heads (pair)

- Polyurethane, non-splintering and non-crumbing
- Highly wear-resistant
- Unscrew used heads in a vice – flare new heads with a few hammer blows



 **Made in Germany**

HAZET No.	l mm	Ø mm	EAN-No. 4000896 +
1953 N-30	113	30	227075
1953 N-35	115	35	227068
1953 N-40	123	40	227051
1953 N-50	133	50	227044
1953 N-60	163	60	227037

 **Made in Germany**

HAZET No.	Ø mm	EAN-No. 4000896 +
1953 N-030	30	227167
1953 N-035	35	227150
1953 N-040	40	227792
1953 N-050	50	227785
1953 N-060	60	227778

SYSTEM 5000-3CT

9 x 12

NEW!

With plug-and-socket connection to accommodate insert tools

• DIN EN ISO 6789-2:2017

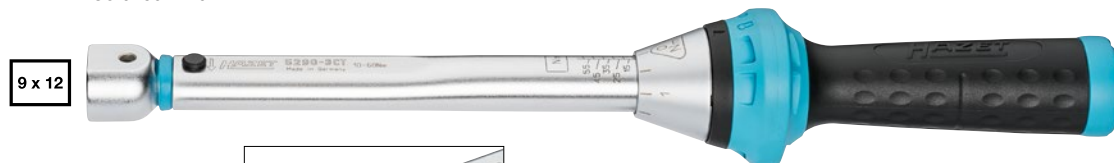

9 x 12

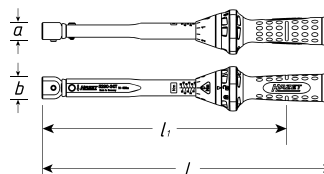

Made in Germany

5290-3CT

EAN-No. 4000896228904

HAZET No.	Output	l mm	l ₁ mm	a mm	b mm	Release accuracy tolerance %	Nm	Nm	
5290-3CT	<input type="checkbox"/> 9x12	291	245	17	22	3	10-60	0.5	3.7-23.4

14 x 18

NEW!



14 x 18

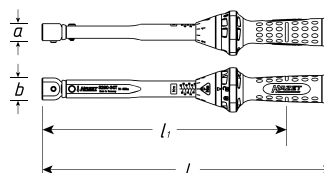

Made in Germany

5292-3CT

EAN-No. 4000896228911

HAZET No.	Output	l mm	l ₁ mm	a mm	b mm	Release accuracy tolerance %	Nm	Nm	
5292-3CT	<input type="checkbox"/> 14x18	484	422	23	30	3	40-200	1	8.9-46.6



Torque insert tool sets

Made in Germany



Insert tools, set of 29 pieces

• For use with, among others, 5290-3CT and 5292-3CT



9 x 12

29

14 x 18

NEW!

Made in Germany

6400 CD/29

EAN-No. 4000896233458



9 x 12

	HAZET No.	Output
①	6630 C-8, -10, -11, -12, -13, -14, -15, -16	
②	6612 C-10, -14, -19, -22	
③	6401-1	
④	6402-1	
⑤	6408	



14 x 18

	HAZET No.	Output
①	6630 D-13, -16, -17, -18, -19, -21, -22 -24, -27	
②	6450 D-24	
③	6414	
④	6404-1	



	HAZET No.	Designation
①	6423 C	Insert adapter ■ 9x12 to □ 14x18
②	6413-4	Sliding square 12.5 1/2" to 10 3/8"

Insert tools, set of 7 pieces

• Ideal for use with e.g. 5290-3CT

9 x 12

	HAZET No.	Output
①	6402-1	
②	6450 C-10, 13, 14, 15, 17, 19	



9 x 12

7

NEW!

Made in Germany

6450C/7

EAN-No. 4000896231102

Insert tools, set of 7 pieces

• Ideal for use with e.g. 5292-3CT

14 x 18

	HAZET No.	Output
①	6404-1	
②	6450 D-16, -17, -18, -19, -22, -24	



14 x 18

7

NEW!

Made in Germany

6450D/7

EAN-No. 4000896231119

SYSTEM 5000-3CT

6.3 1/4" 10 3/8" 12.5 1/2" 20 3/4"

Measuring range from 1 to 800 Nm

± 3% release accuracy tolerance
(5108-3CT – 5145-3CT)



Torque wrench

- Integrated shift lever with free-running function for the measuring ranges 20 – 320 Nm reduces the risk of injury and malfunction **
- Recessed zones in the handle ensure optimum force transmission and non-slip finish thanks to more grip
- Adjustment aid with detent points for optimised operator guidance ensures safe and fast adjustment of the desired torque value by turning the handle
- Safe locking of the setting values by latching function on the blue rotary assembly
- Lock symbols indicate the respective locking status
- Can be attached to the cable loop through openings on the blue rotary assembly
- Trigonometric shape of the blue rotary assembly prevents uncontrolled rolling away
- Optimised sealing ring to protect against debris
- Laser lettering of the metallic scale sleeve and scale ensures permanent legibility
- Tested according to DIN EN ISO 6789-2:2017 with calibration certificate and serial number
- Outside square according to DIN 3120, ISO 1174-1
- Delivery in sturdy Hexa plastic box

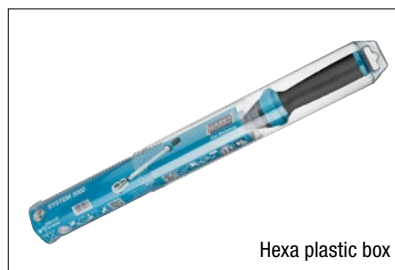

Hexa plastic box

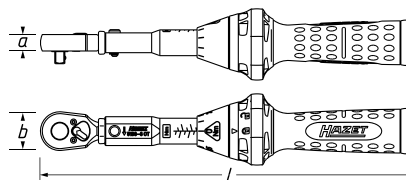

Made in Germany

HAZET No.	Output	l mm	a mm	b mm	Release accuracy tolerance %	Nm	Nm	kg	EAN-No. 4000896 +
5107-3CT	6.3 1/4"	234	10.2	24	4	1–9	0.1	0.6–5.5	218875
5108-3CT	6.3 1/4"	234	10.2	24	3	2.5–25	0.25	1.4–15.3	218882
5110-3CT	10 3/8"	320	14.5	32	3	10–60	0.5	3.9–25.0	218899
5120-3CT	12.5 1/2"	320	14.5	32	3	10–60	0.5	3.9–25.0	218905
5121-3CT	12.5 1/2"	421	19.6	44	3	20–120**	1	6.1–38.0	218912
5122-3CT	12.5 1/2"	519	19.6	44	3	40–200**	1	9.4–49.5	219001
5123-3CT	12.5 1/2"	628	19.6	44	3	60–320**	2	11.3–62.2	218998
5145-3CT	20 3/4"	1271	28.5	64	3	300–800	2.5	26.2–71.0	218929

For a detailed description, see the Tool Catalogue 2020, from page 278

SYSTEM 7000 sTAC SmartTAC

Measuring range from 1 to 1,000 Nm

Display deviation $\pm 1\%$ / ± 1 digit**



Electronic torque wrench with built-in angle gauge for highly precise screwing applications with Smart technology – Ready for Industry 4.0

HAZET Smart Technology consisting of the optional SmartTAC app and Bluetooth Low Energy interface (may be subject to national approval restrictions) with flawless live data exchange to display the screwing process on mobile end devices such as smartphones (Smartwatch) and tablet PCs as well as via a USB-C interface for programming the torque wrench with built-in angle gauge and documentation of the screwing data via laptop and PC. All sTAC torque wrenches with built-in angle gauges can also be used autonomously, without SmartTAC app.

SmartTAC Tool 7910-sTAC

SmartTAC-Tool (7910-sTAC) is the paid programming and evaluation software (for desktop PC and laptop) of the HAZET SmartTAC torque wrench 7000 sTAC.



SmartTAC App

Free for Android
and iOS

Further information in our tool catalogue 2020, page 286 ff.

 Made in Germany

** 7280-5 sTAC, 7281-5 sTAC, 7280-2 sTAC, 7281-2 sTAC, 7280-2 sTAC CAL, 7281-2 sTAC CAL: $\pm 2\%$ / ± 1 digit

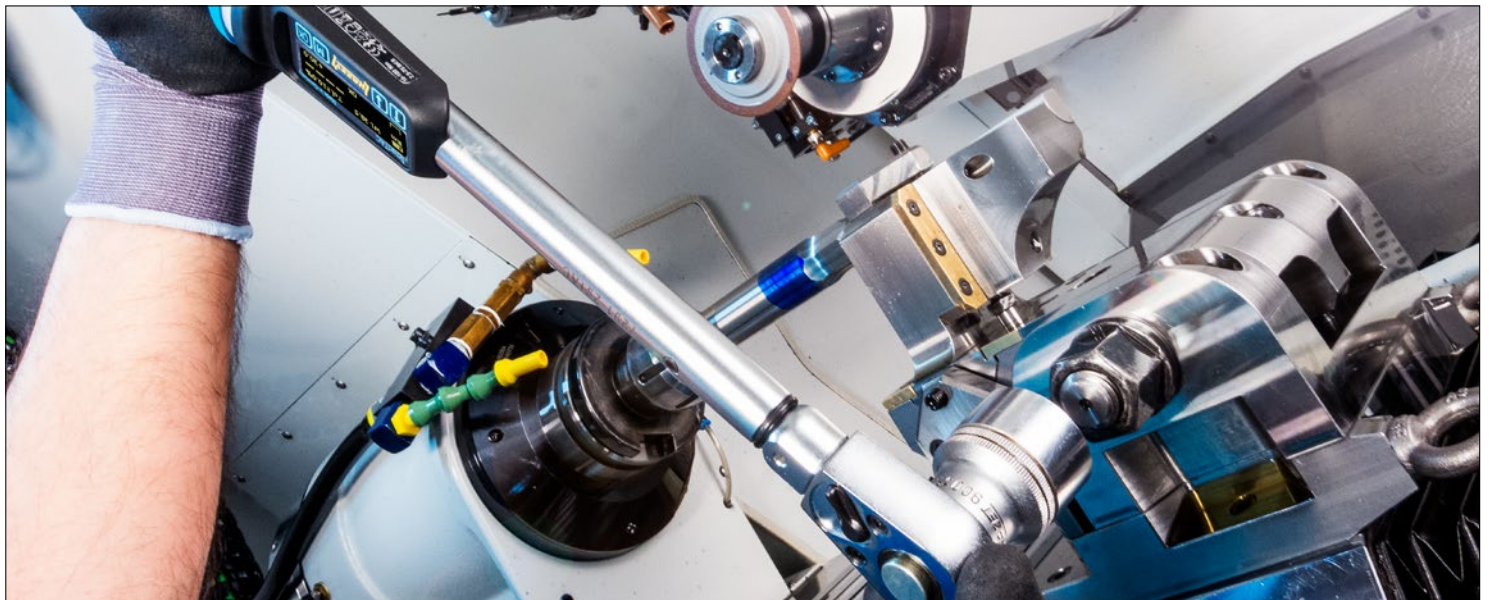

Twin Turbo

Technology by HAZET

- Maximum efficiency due to the ground-breaking HAZET Twin Turbo technology enables high torques with compact design
- Innovative 8-slat air motor with 25% higher impact performance ensures maximum torque
- Long service life and high efficiency in industrial and automotive applications
- Significantly higher performance results in faster loosening of the screw connection during the screwing procedure and is thereby twice as efficient.

Advantage: time saving, as the work procedure is completed faster, thereby consuming less air = cost savings!

Twin Effect – More power in shorter time!

Strongest HAZET impact wrench series ever!

Standard

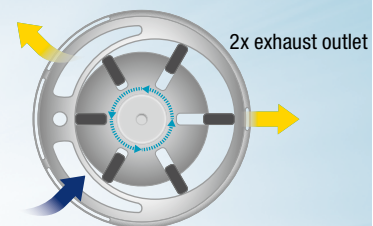

Twin Turbo

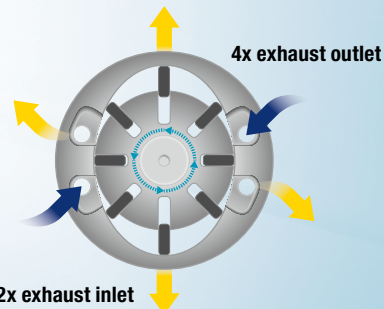

Twin Turbo impact wrench

NEW!



12⁵ 1/2

9012 TT

Max. loosening torque: 2,200 Nm**
Extra short – only 128 mm!

** Determined with screw size M16

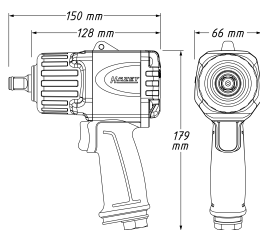

20 3/4

9013 TT

Max. loosening torque: 4,100 Nm**
Extra short – only 184 mm!

** Determined with screw size M32

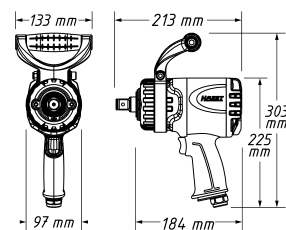

20 3/4

9013 LGTT

Max. loosening torque: 3,800 Nm**

** Determined with screw size M32

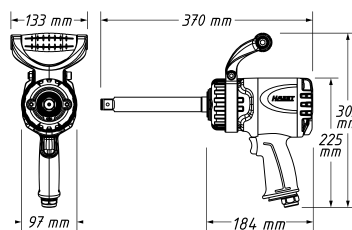

*Length of spindle: 186 mm
For reaching deeply located screw connections*

HAZET No.	■	Nm	Max. Nm	Max. Nm	rpm	kg	Ø mm	l/min	dB(A) Lp A	dB(A) Lp W	m/s ²	✓	✓	EAN-No. 4000896 +
9012 TT	12 ⁵ 1/2	948	1356	2200	8300	1.6	10	243.5	99.7	110.7	8.69	✓	✓	226924
9013 TT	20 3/4	1890	2170	4100	5200	4.5	13	147.2	99.5	110.5	10.69	✓	✓	227143
9013 LGTT	20 3/4	1758	2020	3800	5200	5.5	13	147.2	99.5	110.5	10.69	✓	✓	232277

NEW!



Whisper hoses

- Hose to reduce the noise of the Twin Turbo impact wrenches
- Incl. spring clamp for fixing the hose to the handle

NEW!

HAZET No.	■	l mm	EAN-No. 4000896 +
9040-012	12,91 (4) 1/2	540	232987
9040-013	16,41 (4) 3/4	540	232994

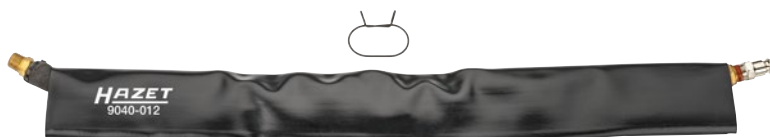

Impact wrenches



10 3/8"

Max. loosening torque:
461 Nm

9011 M

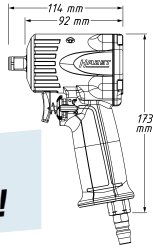

Extra short!



12.5 1/2"

Max. loosening torque:
1,200 Nm

9012 M-1

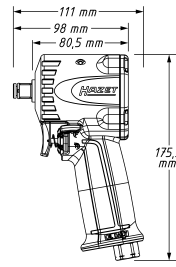

Even stronger and shorter!

12.5 1/2"

Max. loosening torque:
450 Nm

9012 A-1

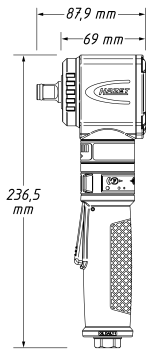

Angled!



12.5 1/2"

Max. loosening torque:
850 Nm

9012 SPC

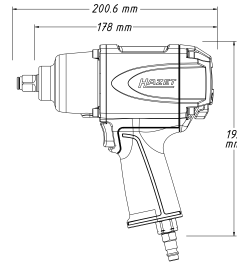

20 3/4"

Max. loosening torque:
1890 Nm

9013 M

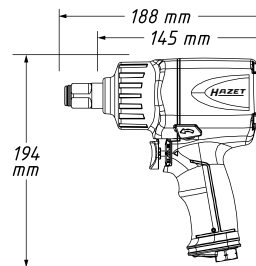

Only 2.1 kg!



20 mm (3/4") impact wrench
in 12.5 mm (1/2") housing size!

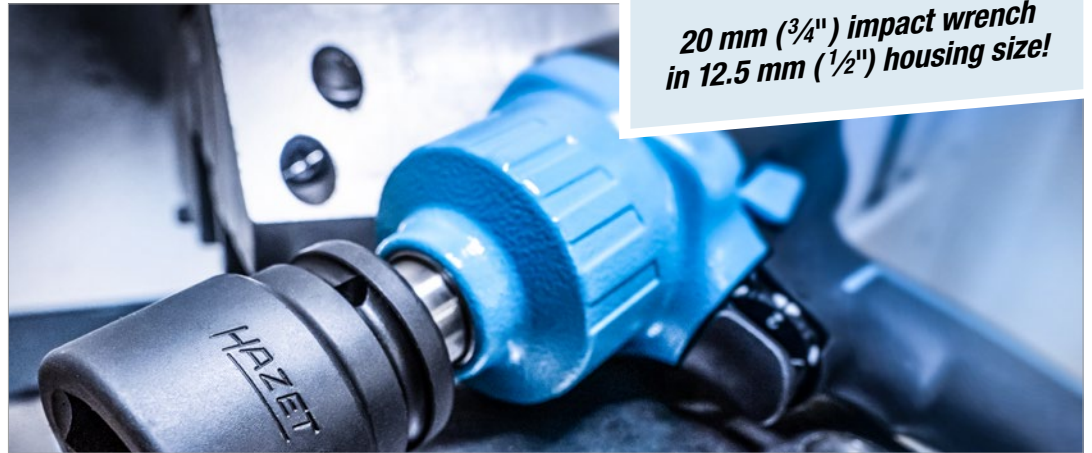

Pin clutch mechanism



Single hammer striking mechanism



Twin hammer mechanism



Direct striking mechanism

HAZET No.	Max. Nm	rpm	kg	l/min	db (A) Lp A	m/s ²					EAN-No. 4000896+			
9011 M	10 3/8"	461	6500	1.2	85.2	90.3	7.78	✓	12.91(H) 12.91(L) 72	–	✓	–	–	201570
9012 M-1	12.5 1/2"	1200	8800	1.27	127.4	92.2	13.49	✓	12.91(H) 12.91(L) 72	–	✓	–	–	218356
9012 A-1	12.5 1/2"	450	8500	1.16	113	92.2	9.96	✓	12.91(H) 12.91(L) 72	–	✓	–	–	218301
9012 SPC	12.5 1/2"	850	7000	2.6	127.4	92.1	7.42	✓	12.91(H) 12.91(L) 72	✓	–	–	–	119639
9013 M	20 3/4"	1890	7300	2.1	153	104	7.47	✓	16.41(H) 16.41(L) 72	–	–	✓	–	212347

Silicone protective covers

9012 M-S	Can be used for 9011 M and 9012 M	202232
9012 M-1-S	Can be used for 9012 M-1	222735
9012 SPC-S	Can be used for 9012 SPC, 9012-1SPC, 9012 P-1	222476



Mini air ratchet

6.3 1/4" 9020 P-2

- Max. loosening torque: 40 Nm
- For hand retightening with torque values > 60 Nm

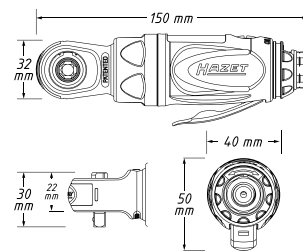

10 3/8" 9021 P-2

- Max. loosening torque: 54 Nm
- For hand retightening with torque values > 260 Nm

Impact ratchet

10 3/8" 9021 SR-1

- Max. loosening torque: 68 Nm
- For hand retightening with torque values > 260 Nm

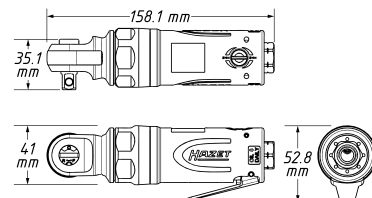

Air ratchet

12.5 1/2" 9022 P-2

- Max. loosening torque: 108 Nm
- For hand retightening with torque values > 400 Nm

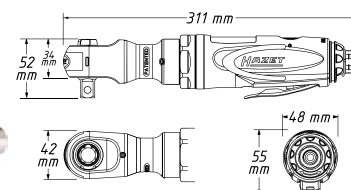

Impact ratchet

12.5 1/2" 9022 SR-1

- Max. loosening torque: 102 Nm
- For hand retightening with torque values > 270 Nm

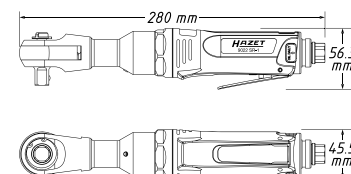

High performance air ratchet

12.5 1/2" 9022-360

- Max. loosening torque: 120 Nm
- For hand retightening with torque values > 500 Nm (competitive product: approx. 250 Nm)



360° rotatable operating lever

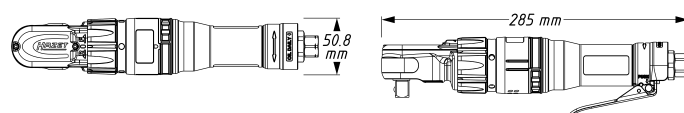

Extra long air ratchet

12.5 1/2" 9022 P-XLG

- Max. loosening torque: 94.8 Nm
- For hand retightening with torque values > 400 Nm

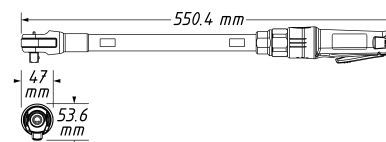

HAZET No.	■	max. Nm	rpm	kg	l/min.	db(A) Lp A	m/s ²			EAN-No. 4000896 +
9020 P-2	6.3 1/4"	40	250	0.5	72	90	12.24	✓	12.91mm 7.2	184323
9021 P-2	10 3/8"	54	300	0.5	103	92	10.23	✓	12.91mm 7.2	184545
9022 P-2	12.5 1/2"	108	280	1.24	113	99	7.47	✓	12.91mm 7.2	184538
9021 SR-1	10 3/8"	68	500	0.67	68	82	9.84	✓	12.91mm 7.2	218295
9022 SR-1	12.5 1/2"	102	400	1.99	113	91	4.53	✓	12.91mm 7.2	170593
9022-360	12.5 1/2"	120	200	1.55	107.6	91.2	4.87	✓	12.91mm 7.2	209781
9022 P-XLG	12.5 1/2"	94.8	160	2.1	99.12	93.7	5.6	✓	12.91mm 7.2	222513



Belt sander

- Three abrasive belts included 330 x 10 mm (grain size 80, 100, 120)
- For narrow surfaces (belt width 10 mm)
- Locking device for quick belt changing
- Continuous speed regulation via speed regulator on back of handle
- Automatic belt adjustment



Right-angle grinder

- For areas with difficult access
- Lateral handle, to be used on left or right side
- Quick adjustment of protection cover without tools
- For grinding discs 0.8–6 mm thick
- Spindle thread: M 14 x 2



Angle grinder

- Suitable for cutting metal sheet and steel
- Quick adjustment (without tools) of protective cover
- Pressure key for locking the output enables easy changing of cut-off wheels
- Low build height



Angle grinder

- For processing workpieces even in areas with very restricted access
- Power: 522 Watts
- Including 1 cut-off wheel
- Forward/reverse for controlling flying sparks
- Continuous speed regulation



HAZET No.	mm	rpm	kg	l/min	db (A) Lp A	m/s ²	mm		EAN-No. 4000896 +
9033 N-4	–	19000	0.8	94	83.8	1.88	330 x 10	✓ 12,81 (H) 7,2	210183
9033 N-7	10	12000	2	113	85	6.5	125 x 22	✓ 12,81 (H) 7,2	205547
9033 P-8	10	14000	1.7	113	89.5	3.65	100x0.8x9.53	✓ 12,81 (H) 7,2	190515
9033-10	10	18000	0.9	114	88	1.8	76 x 2.1 x 10.0	✓ 12,81 (H) 7,2	196371



Spare parts



HAZET No.	Spare part for HAZET items	Design	EAN-No. 4000896 +
①	Belt sander 9033 N-4	Abrasive belt set, grain size 80	10 139101
		Abrasive belt set, grain size 100	10 139118
		Abrasive belt set, grain size 120	10 139125
②	Right-angle grinder 9033 N-7	Cut-off wheel set	5 219063
		Cut-off wheel set	25 219070
		Rough grinding wheel set	10 219087
③	Angle grinder 9033 P-8	Cut-off wheel set	5 201549
		Cut-off wheel set	25 201402
④	Angle grinder 9033-10	Cut-off wheel set	5 199969



Micro die grinder

- Power: 190 Watts
- 3 mm collet chuck

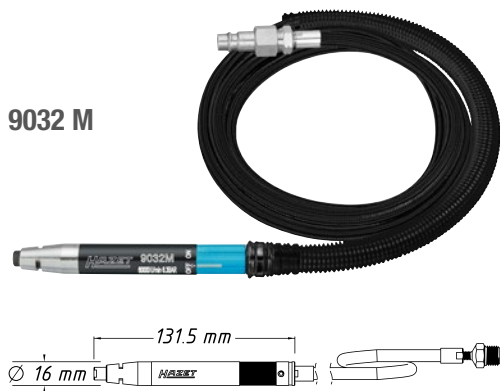

Mini die grinder

- Power: 224 Watts
- 6 mm collet chuck with 3 mm adapter to accommodate both grinding pad dimensions

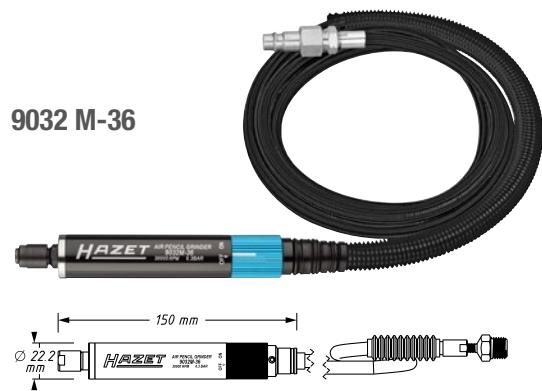
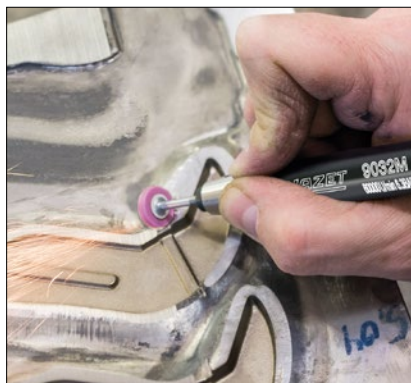

Range of mini pneumatic tools

- Extremely small and handy
- High reliability and continuous operation
- Incl. safety operating lever (except 9023 M-1)
- Innovative 5-slat concept for even more power than conventional drives



Mini die grinder, straight design

- Power: 224 Watts
- For working in areas with difficult access
- Extremely lightweight, handy device for grinding, polishing, burnishing and deburring
- Exhaust air is guided through the handle



9032 M-1

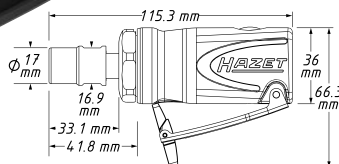

Mini die grinder, angled

- Power: 224 Watts
- Heavy duty multi-bearing gearbox with a 2.5 times longer service life compared to conventional gearboxes
- Extremely lightweight, handy device for grinding, polishing, burnishing and deburring
- For working in areas with difficult access
- Exhaust air is guided through the handle



9032 M-5

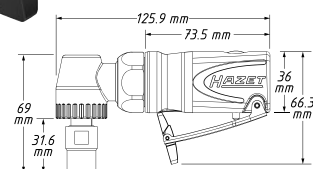

HAZET No.	mm	rpm	kg	Ø mm	l/min	dB(A) Lp A	m/s ²	12,91kV	EAN-No. 4000896 +
9032 M	3	60,000	0.3	5	75	80.4	0.8		195152
9032 M-36	3/6	30,000	0.38	5	43.7	78.7	1.80		209606
9032 M-1	6	25,000	0.33	10	84	82.4	1.8		227099
9032 M-5	6	18,000	0.48	10	84	81.9	5.1		227105

Spare parts

HAZET No.	Designation	EA	EAN-No. 4000896 +
① 9032-03S	3 mm collet chuck (9032M-1, 9032 M-5, 9032N-1, 9032N-5, 9032P-1)	1	228928
② 9032-03/5	Carbide milling pin set 3 mm (9032M, 9032M-36)	5	222483
③ 9032-06/3	Carbide milling pin set 6 mm (9032M-36)	3	222667



Mini right-angle grinder

• Power: 224 Watts



9033 M-7

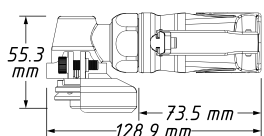

Mini polisher

• Power: 224 Watts



9033 M-9

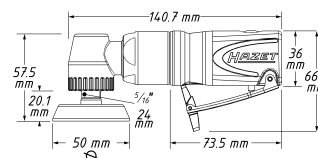

Mini disc sander, angled

• Power: 224 Watts



9033 M-11

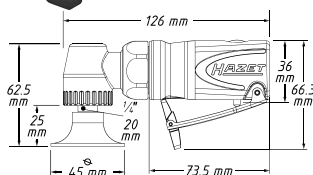

Mini multifunctional air ratchet

• Power: 224 Watts

Contents:

- Sliding ratchet 17 mm
- Socket 1/4"
- Socket 3/8"
- Screwdriver bit 6.3 mm



9023 M-1



HAZET No.	max. Nm	rpm	kg	∅ mm	l/min	dB(A) Lp A	dB(A) Lp W	m/s ²	✓	12.911+ 7/2	EAN-No. 4000896 +
9033 M-7	-	18000	0.53	10	84	85.8	96.8	1.9	✓	12.911+ 7/2	227242
9033 M-9	-	4500	0.60	10	84	83.6	94.4	1.9	✓	12.911+ 7/2	227235
9033 M-11	-	18000	0.44	10	84	84.2	95.2	1.8	✓	12.911+ 7/2	227129
9023 M-1	54	400	0.48	10	84	82.8	93.8	3.2	✓	12.911+ 7/2	227112

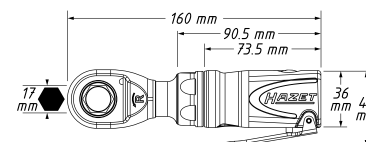

Spare parts

	HAZET No.	Designation	Design	10	EAN-No. 4000896 +
	9033 M-07/10	Cut-off wheels, max. cutting speed 100 m/s	For steel and stainless steel	10	229680
9033 M-9	9033-5-01/10	Spare grinding pads, 320	Grain size: 320	10	160525
	9033-5-02/10	Spare grinding pads, 400	Grain size: 400	10	160730
	9033-5-03/10	Spare grinding pads, 600	Grain size: 600	10	160747
	9033-5-08/10	Spare grinding pads, 800	Grain size: 800	10	228317
	9033 M-9-010	Polishing pads	Flat	5	228324
	9033 M-9-011	Polishing pads	Curved	5	228331
9033 M-9-01	Polishing disc	50 mm	1	228362	
9033 M-11	9033-11-080/5	Non-woven abrasive set, 80	Grain size: 80	5	228270
	9033-11-0150/5	Non-woven abrasive set, 150	Grain size: 150	5	228256
	9033-11-0300/5	Non-woven abrasive set, 300	Grain size: 300	5	228263
	9033-11-S060	Spare grinding pads, 60	Grain size: 60	5	228287
	9033-11-S080	Spare grinding pads, 80	Grain size: 80	5	228294
	9033-11-S120	Spare grinding pads, 120	Grain size: 120	5	228300
	9033M-11-015	Grinding disc	∅ 50 mm	1	228355
	9033-11-020/4	Strip wheel set	Hard variant	4	222834
	9033-11-030/4	Strip wheel set	Soft variant	4	222728
	9033-11-036/2	Spare bristle grinder set, purple	Grain size: 36	2	222872
	9033-11-050/2	Spare bristle grinder set, green	Grain size: 50	2	222865
9033-11-0120/2	Spare bristle grinder set, white	Grain size: 120	2	222858	
9023 M-1	9023 M-1-020	Ratchet socket	1/4"	1	228225
	9023 M-1-021	Ratchet socket	3/8"	1	228232
	9023 M-1-B	Ratchet socket	Screwdriver bit	1	228249



Bristle grinder set

- For gentle yet effective cleaning of surfaces
- Roloc™ quick-change system allows the plastic brush to be changed quickly and easily without any extra tool

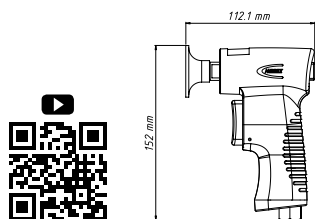

9033-11/17



17

HAZET No.	Ø mm	rpm	Kg	l/min	bar	Power		Ø mm	dB(A) Lp A	dB(A) Lp W	m/s	EAN-No. 4000896+
						HP	Watts					
9033-11/17	50	15000	0.54	79	6.3	0.3	224	10	75	86	✓	222575

Sabre saw

- Increased efficiency with reduction of weight, air consumption, noise generation and vibration
- Direction of air exhaust adjustable
- Saw stroke: 10 mm
- Strokes/min.: 9500
- Cutting capacity in sheet steel 3 mm, aluminium: 4 mm



9034 P-2

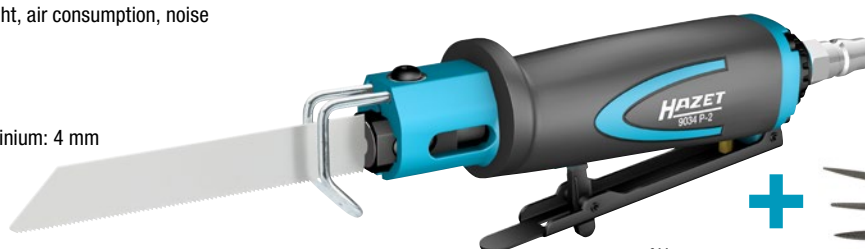

HAZET No.	kg	Ø mm	l/min	db (A) Lp A	m/s ²	EAN-No. 4000896+
9034 P-2	0.4	10	99	86.7	6.13	218288

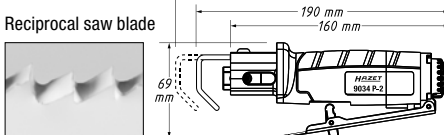

11

Switchable air blow and suction gun

- For sucking up dirt into the dust collection bag as well as for blowing surfaces clean
- With speedy one-hand switching of the function direction



9043 N-10

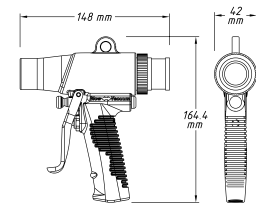
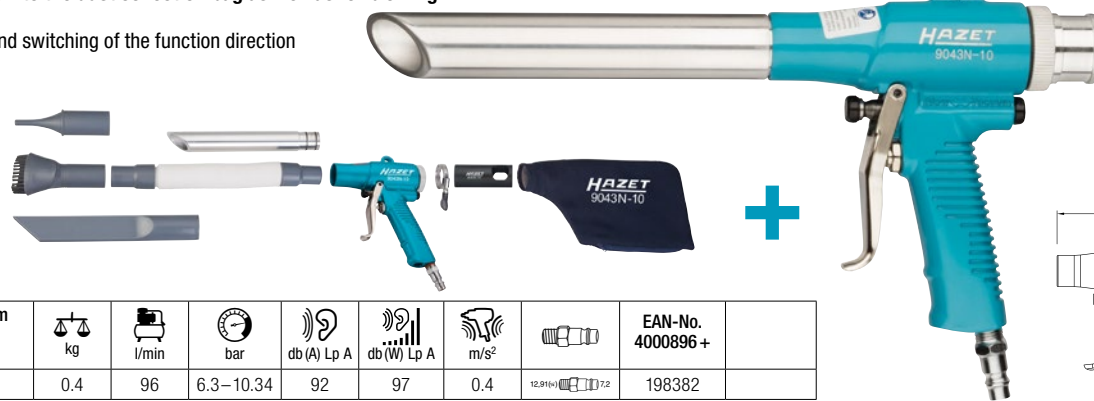

HAZET No.	Vacuum level mmHg	kg	l/min	bar	db (A) Lp A	db (W) Lp A	m/s ²	EAN-No. 4000896+
9043 N-10	7.5	0.4	96	6.3-10.34	92	97	0.4	198382

9

Spare parts

	HAZET No.	Designation	Design	■	EAN-No. 4000896+
9033-11	9033-11-015	Plate bristle grinder	Ø 50 mm	1	222841
	9033-11-020/4	Strip wheel set	Hard variant	4	222834
	9033-11-030/4	Strip wheel set	Soft variant	4	222728
	9033-11-036/2	Spare bristle grinder set, purple	Grain size: 36	2	222872
	9033-11-050/2	Spare bristle grinder set, green	Grain size: 50	2	222865
	9033-11-0120/2	Spare bristle grinder set, white	Grain size: 120	2	222858
9034 P-2	9034 P-R/5	Reciprocal saw blades, chamfered teeth	Length: 135 mm	5	218318
	9034 P-050/5	File set	Length: 135 mm	5	218349
	9034 P-018/5	Saw blades	18 teeth	5	225958
	9034 P-024/5	Saw blades	24 teeth	5	225965
	9034 P-032/5	Saw blades	32 teeth	5	225989
	9043 N-10-08/2	Fine dust bag for 9043 N-10. Particularly suitable for sucking up fine dust		1	222827





NEW!



9035 M-5

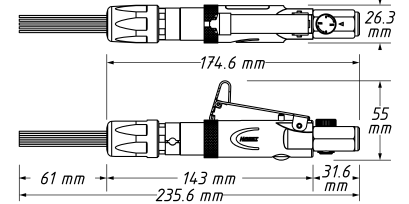

Mini needle striker

- Gentle cleaning of soiled / rusted parts
- **13 needles, Ø 1.3 mm**
- 3,000 impacts/min
- With safety lever
- With rotary joint for easy handling
- Infinite adjustable power
- Extremely handy tool
- Pin shape for flexible handling
- Free needles allow you to reach difficult to access areas as well
- Coupler plug: nominal size 7.2 (included)

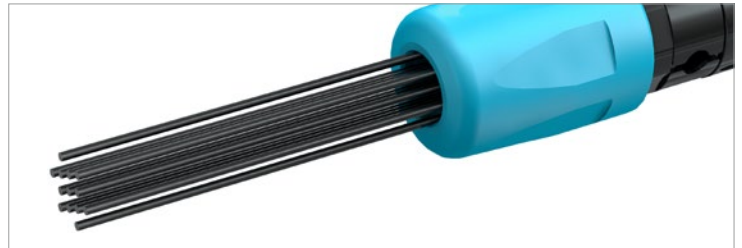

9035-5



Needle scaler

- Precisely removing rust and such
- **19 needles, Ø 3 mm**
- 3,200 impacts/min
- Adjustable needle cover
- Pistol shape
- Adjustable needle cover enables maximum utilisation of needles
- Two-piece housing design for easy maintenance
- Coupler plug: nominal size 7.2 (included)

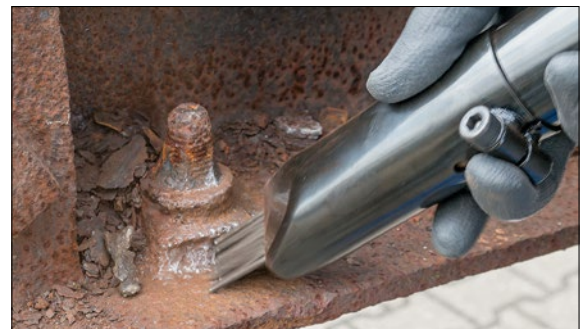
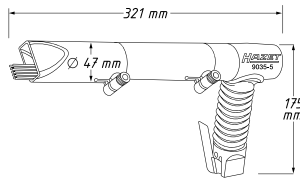

HAZET No.	Kg	l/min	db (A) Lp A	m/s	7.2	EAN-No. 4000896+
9035 M-5	0.48	48.1	87.9	6.9	7.2	232284
9035-5	2.6	170	97	8.7	7.2	132355

NEW!

Spare parts

HAZET No.	Designation	Ø mm		EAN-No. 4000896+
9035 M-050	Spare needles for 9035 M-5	1.3	13	233205
9035-050	Spare needles for 9035-5	3	19	139385

NEW!



Chisel hammer set

• Including keyless drill chuck

9035 H/6 **6**

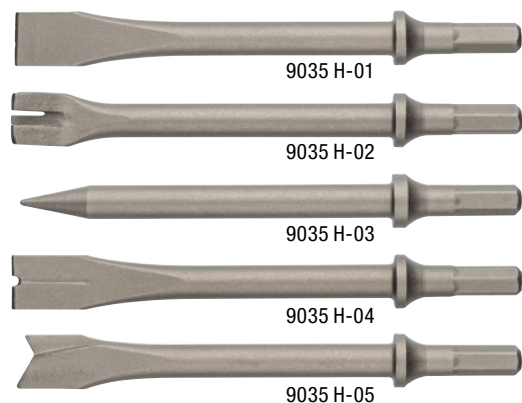

9035 H-01

9035 H-02

9035 H-03

9035 H-04

9035 H-05

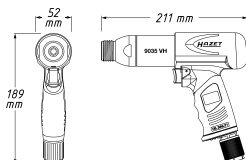

Vibration chisel set

• Including keyless drill chuck

9035 V/5 **5**

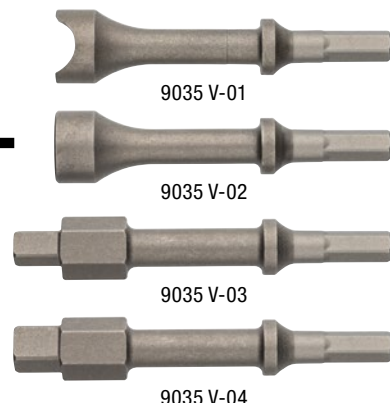

9035 V-01

9035 V-02

9035 V-03

9035 V-04

One basic unit – many options!

kg	l/min	bar	db(A) Lp A
2.5	57–594	6.3	92–105



HAZET No.	Designation	■	EAN-No. 4000896+	
9035 H/6	Chisel hammer set, incl. 9035 H-01, -02, -03, -04, -05	6	214655	
9035 V/5	Vibration chisel set, incl. 9035 V-01, -02, -03, -04	5	213368	
9035 VH	Basic unit, in case incl. keyless drill chuck	1	214020	
9035 VH-01	Keyless drill chuck	1	214242	
9035 H	9035 H-01	1	214136	
	9035 H-02	1	213924	
	9035 H-03	1	214198	
	9035 H-04	1	214143	
	9035 H-05	1	214525	
9035 V	9035 V-01	1	214181	
	9035 V-02	1	214174	
	9035 V-03	1	214167	
	9035 V-04	1	214150	
	9035 V-05	1	227266	
	9035 V-06	Vibration drift pin 6 mm	1	227259
	9035 V-08	Vibration drift pin 8 mm	1	227297
	9035 V-09	Curved vibration chisel	1	227280
	9035 V-010	Vibration drift pin 10 mm	1	227273

Further chisels and drift pins

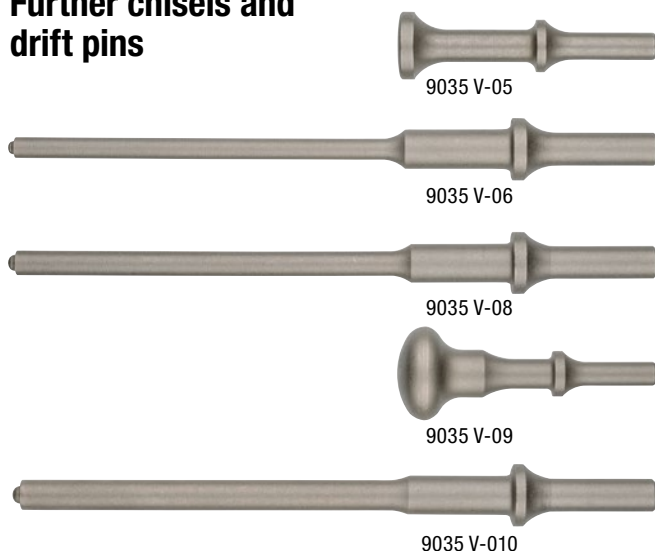

9035 V-05

9035 V-06

9035 V-08

9035 V-09

9035 V-010



Cyclonic cleaning gun

- For perfectly cleaning contaminated surfaces such as upholstered areas, foot mats with animal hair, dirt as well as for vehicle preparation, rim and part cleaning with suitable cleaning agents
- The working pressure can be set to the cleaning medium for processing or the specific application via the setting wheel on the handle (read processing notes of cleaning manufacturer)
- Includes brush attachment
- Air inlet inside thread (IG) (1/4")
- Not for sale in the USA



9043 N-1

Accessories

- Optional suction attachment for cyclonic cleaning gun HAZET 9043N-1
- Not for sale in the USA



9043 N-2

Delivery without 9043 N-1

Air blow guns 9040

- With bent pipe \varnothing 8 mm, 100 mm
- Application field: -10°C to $+80^{\circ}\text{C}$



9040 P-1

Standard nozzle

- With straight pipe \varnothing 8 mm, 300 mm
- Application field: -10°C to $+80^{\circ}\text{C}$



9040 P-2

Long nozzle

- With bent pipe \varnothing 8 mm, 100 mm
- Extreme reduction of noise
- Non-blocking



9040 P-3

Quiet nozzle

- With bent pipe \varnothing 8 mm, 100 mm
- 100% increase in air outlet quantity thanks to Venturi nozzle
- Non-blocking



9040 P-4

Venturi nozzle

- With wide flat nozzle for cleaning surfaces
- Low noise
- Non-blocking



9040 P-5

Wide nozzle

- 2-way air blow gun
- Choice of air supply at tool head or handle
- Pressure regulator and replaceable nozzles



9040-4

Top seller!

HAZET No.		kg	\varnothing mm	l/min	Bar	db (A) Lp A	m/s ²		l mm	EAN-No. 4000896 +
9043 N-1		0.76	10	254	4-6.3	88.3	1.44	✓	354	221783
9043 N-2	-	0.45	-	-	-	-	-	-	374	222506
9040 P-1		0.11	-	290	6	84	-	✓	247	209545
9040 P-2		0.19	-	290	6	84	-	✓	420	209552
9040 P-3		0.10	-	245	6	76.8	-	✓	255	209644
9040 P-4		0.17	-	235	6	83.7	-	✓	265	209569
9040 P-5		0.10	-	450	6	78	-	✓	203	209576
9040-4		0.20	-	330	6	86	-	✓	100	176236



With 112 mm nozzle





Car body gun for underbody protection and cavity sealing

- Including metal suction pipe
- Suitable for aqueous and oily liquids
- Including nozzle and cavity tube
- Application field: -10°C to +80°C
- Air requirement with cavity tube: 180 l/min at 8 bar
- Nozzles made of steel / plastic



HAZET No.	kg	l/min	bar		EAN-No.
9042 P-4	0.35	255	6		4000896+ 209613



Soda spray gun

- Mineral spray gun for damage-free cleaning and removal of paint
- No heating / deformation of sheets during blasting
- Removes paint from wooden objects without any damage
- Removes paint from glass surfaces and window frames without causing damage to glass and seals
- For the gentle removal of graffiti as well as for cleaning facades and monuments
- With preset precision nozzle for optimal performance
- For blasting with NaHCO₃ (sodium bicarbonate)

Including 1 kg of soda blast-cleaning agent!

Incl 1x metal nozzle



Incl. 3x wide jet nozzle

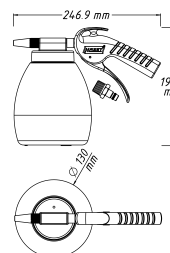

HAZET No.	kg	l/min	bar	db (A) Lp A	db (W) Lp A	m/s ²	EAN-No.
9045 P-1	0.46	280	6 - 12	88.3	89.4	1.44	4000896+ 209590

Blind rivet gun

- Professional riveting, suitable for continuous operation with rivets of up to 6.4 mm made of steel, stainless steel, aluminium and copper
- Possible rivet sizes: 3.0 - 3.2 - 4.0 - 4.8 - 5.0 - 6.0 and 6.4 mm
- 5 nose pieces
- Flexible connecting nipple
- Total stroke: 15.8 mm
- High tractive power: 14700 N
- Particularly low noise level
- Includes maintenance set for oil control (oil-supported pressure build-up)



HAZET No.	kg	l/min	l mm		EAN-No.
9037 N-2	2.11	2.64	296.6		4000896+ 205578

Grease gun

- Continuous pumping of grease
- Gun-filling with grease cartridge, loose grease or via dispenser
- Compaction: 40:1
- 360° adjustable handle
- Filling capacity: approx. 400 ml

Incl. 1x



HAZET No.	kg	l/min	l mm Nylon hose	l mm Metal tube	EAN-No.
9042 N-1	2	230	230	172	4000896+ 176472

Accessories for 9045 P-1

HAZET No.	Designation	kg	EAN-No.
9045 P-5S	Soda blast-cleaning agent, 5 kg for soda spray gun 9045 P-1	5	210404



Hose reel

- Suitable for compressed air or water
- Black hybrid polymer hose
- Automatic guidance winds the hose neatly
- 9040 N-13: Meets all relevant requirements defined in European Machinery Directive 2006/42/EC

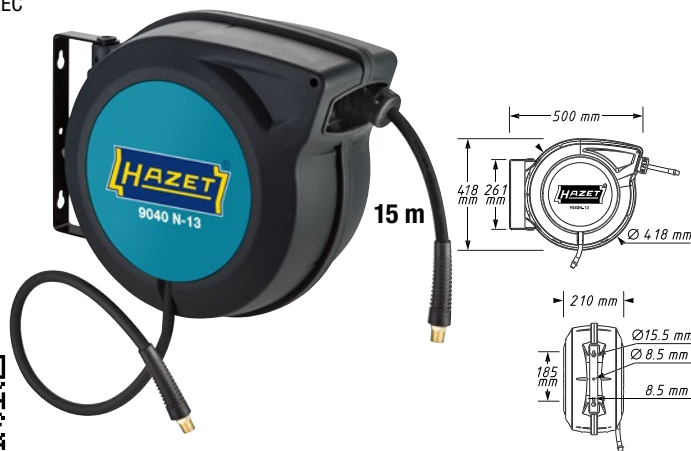

HAZET No.	°C	Outside thread	Hose inside Ø mm	bar	kg	EAN-No. 4000896+
9040 N-10	-40/+60°	16.41 mm 3/8"	10	20	6.45	206445
9040 N-13	-40/+80°	20.96 mm 1/2"	13	20	9.5	214648

Cable reel

- Including line circuit breaker
- Only suitable for indoor use



HAZET No.	°C	watts	watts	kg	EAN-No. 4000896+
9040 D-2.5	-20/+45°	1600	3200	9.2	214631

Spiral hose

- High flexible polyurethane hose
- Connecting pieces with 360° rotary joints



HAZET No.	l m	Burst pressure according to DIN	Hose inside Ø mm	bar	12,91(+)	7,2	EAN-No. 4000896+
9040-7	7.62	55.1 bar/800 PSI	6.35	10	12,91(+)	7,2	153404
9040 S-10**	7.62	60 bar	10	10	12,91(+)	7,2	212361

** Recommended by HAZET for commercial application Ø 10 mm

Compressed air hoses with quick coupling and connecting nipple

- Grouted coupler bushing / coupler plug included
- PVC compressed air hose
- Corresponding to DIN EN ISO 5774:2008 "Hydrostatic requirements" (Type C)
- Burst pressure: 45 bar



Made in Germany

HAZET No.	Ø mm	l m	EAN-No. 4000896+
9040-610	6	10	221929
9040-620	6	20	221912
9040-1010**	10	10	221899
9040-1020	10	20	221905

** Recommended by HAZET for commercial application Ø 10 mm

Mini grease gun

- Creates pressure up to 1,000 PSI/69 bar
- Suitable for filling with loose grease
- Incl. lubricating nipple in 50° and 90° designs



2162 M

High performance lubricant

- Optimal for quickly and cleanly filling the HAZET mini grease gun 2162 M



9300 N-60

Mini oiler

- Supports longevity and permanent functionality
- Reduces wear of the air motor
- Working pressure: 6 bar



9070 N-1

HAZET No.	Designation	EAN-No. 4000896+
2162 M	Mini grease gun, filling capacity: 80 g, length: 145 mm, weight: 0.27 kg	185634
9300 N-60	High performance lubricant, 60 ml	203406
9070 N-1	Mini oiler, 28 ml	206407
9400-100	Special pneumatic tool oil, 100 ml	191390
9400-1000	Special pneumatic tool oil, 1000 ml	191406

Special pneumatic tool oil

Made in Germany

9400-100 / 9400-1000





9000-040



Rotary joint with continuous air flow rate reducer

- 360° rotation joint in 2 axes
- Air flow regulation by means of setting wheel
- Release of the rotating function through compressed air supply, rigid in unpressurised condition



9000-041



Rotary joint

- 360° rotation joint in 2 axes
- Maximum pressure: 16 bar



9000-080

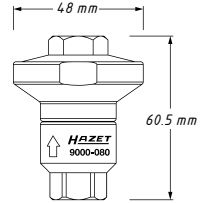

Compressed air reducer

- Reduction of working pressure to protect high-quality pneumatic equipment
- Inline pressure regulator for integration in the compressed air line or direct connection to motorised pneumatic equipment
- Including:
 - Adapter from outside thread (AG) (1/4") to outside thread (AG) (1/4") for connecting to the device
 - Air connection nipple 7.2 Type 1 for connection to compressed air coupling
- Max. inlet pressure: 10 bar
- Outlet pressure: 6.3 bar

HAZET No.	Outside thread	Inside thread	Air inlet	kg	EAN-No. 4000896+
9000-040	12.91 mm 1/4"	12.91 mm 1/4"	12.91 mm 1/4"	0.09	195350
9000-041	12.91 mm 1/4"	12.91 mm 1/4"	12.91 mm 1/4"	0.07	204441
9000-080	12.91 mm 1/4"	12.91 mm 1/4"	12.91 mm 1/4"	0.1	214709

Safety couplings

- Safe disconnection of the connection (unwanted disconnection is excluded)
- No risk of injury from hose impact
- Safety coupling depressurizes the connection before decoupling
- One-hand operation
- Little effort during coupling and decoupling
- Omission of loud popping during coupling process
- Easy operation, even with gloves
- 9000-050 up to 9000-070 brass, nickel-plated

9000-050, EAN-No. 4000896195275

Safety coupling 12.91 mm 1/4" outside thread (AG)



9000-060, EAN-No. 4000896195312

Safety coupling 12.91 mm 1/4" inside thread (IG)



9000-070, EAN-No. 4000896195305

Safety coupling with 10 mm hose nipple

- For hose mounting



9000-051, EAN-No. 4000896195282

Safety coupling 16.41 mm 3/8" outside thread (AG)



9000-061, EAN-No. 4000896195299

Safety coupling 16.41 mm 3/8" inside thread (IG)

- Suitable for 9040N-10



9000-062, EAN-No. 4000896218936

Safety coupling 20.95 mm 1/2" inside thread (IG)

- Suitable for 9040N-13

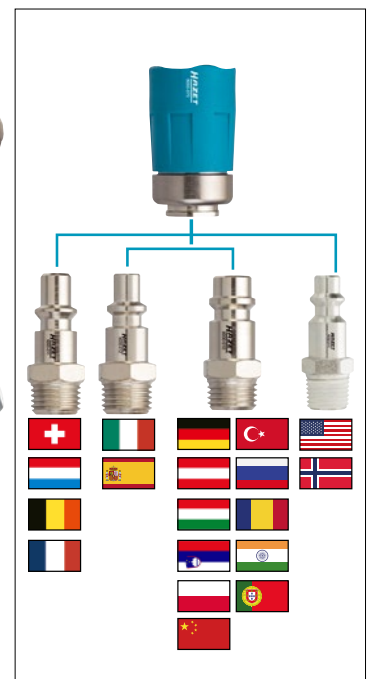
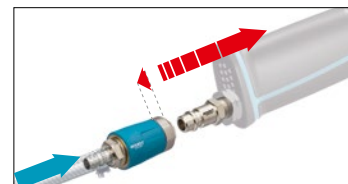
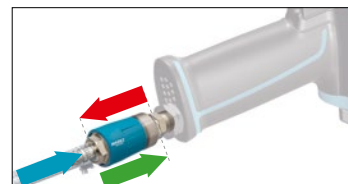
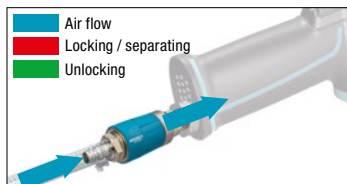

Not recommended for 3/4" and 1" devices or those with strong vibrations (applies for all safety couplings shown here apart from 9000-062)
You can find rotary joints and air connection nipples/hose nipples in the tool catalogue 2020 from page 341

One rechargeable battery system for all devices!



HAZET No.	Designation	EAN-No. 4000896 +	
9212-02	Replacement Li-ion rechargeable battery 2.0 Ah	213788	
9212-05	Replacement Li-ion rechargeable battery 5.0 Ah	210367	
9212-03	Quick charger for rechargeable batteries	204823	

Cordless drilling machine 18 V, 2.0 Ah

- Tool-free metal quick-clamping drill chuck 1–13 mm
- Incl. quick charger (40 minutes)
- Selectable torque settings 15 + 1 drilling

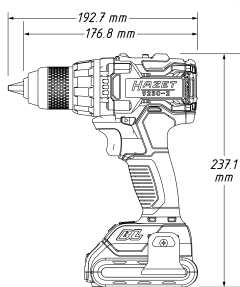

9230-2



max. Nm	rpm	rpm	db (A) Lp A	Screwing / m/s ²	Drilling / m/s ²	without rechargeable battery/kg
60	1 0–560	2 0–1900	68	0.8	2.3	1.27

Cordless right-angle grinder 18 V, 5.0 Ah

- High efficiency thanks to brushless motor
- Device stops if the speed drops sharply due to canting
- With function against unintentional motor start when changing the battery
- Mesh fabric protects motor from dirt
- Motor stop 2 seconds after switch-off
- Constant speed even during difficult work
- Soft startup for greater comfort
- With safety lever
- Quick adjustment of protection cover without tools
- Spindle thread: M14



9233-7

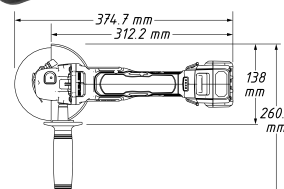

rpm	db (A) Lp A	m/s ²	With rechargeable battery / kg	without rechargeable battery / kg
8000	89	7.9	2.28	1.53



HAZET No.	Designation		EAN-No. 4000896 +
9230-010	Drilling machine basic unit (without rechargeable battery)	1	218974
9230-2	3-piece set: 1 cordless drilling machine, 1 quick charger, 1 Li-ion rechargeable battery 18 V, 2.0 Ah	3	218370
9230-2/4	4-piece set: 1 cordless drilling machine, 1 quick charger, 2 Li-ion rechargeable batteries 18 V, 2.0 Ah	4	218967
9233-010	Right-angle grinder basic unit (without rechargeable battery)	1	218943
9233-7	3-piece set: 1 cordless right-angle grinder, 1 quick charger, 1 Li-ion rechargeable battery 18 V, 5.0 Ah	3	218325
9233-7/4	4-piece set: 1 cordless right-angle grinder, 1 quick charger, 2 Li-ion rechargeable batteries 18 V, 5.0 Ah	4	218950

Accessories for right-angle grinder 9233

HAZET No.	Designation		EAN-No. 4000896 +
9233-010/5	Cut-off wheel set, 5-piece	5	219063
9233-011/10	Rough grinding wheel set, 10-piece	10	219087
9233-010/25	Cut-off wheel set, 25-piece	25	219070



Top seller

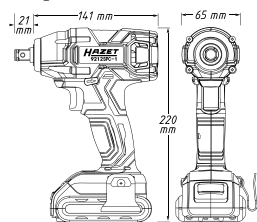

12⁵ 1/2
9212 SPC-1



State-of-charge display

3



Mini

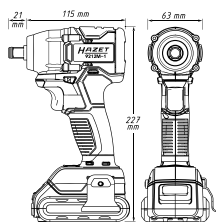

12⁵ 1/2
9212 M-1

Torque positions



State-of-charge display

3



Including

Cordless impact wrench 18 V, 2.0 Ah

- Max. loosening torque: 260 Nm
- Max. tightening torque: 200 Nm
- Extremely handy tool
- Amperage without load: 5 A
- Charging time ~ 35 min
- Belt clip included
- **Contents:**
Cordless impact wrench, charging device, Li-ion rechargeable battery 2.0 Ah (1x), high-quality carrying case



Mini cordless impact wrench 18 V, 2.0 Ah

- Max. loosening torque: 270 Nm
- Max. tightening torque: 220 Nm
- Extremely handy and short tool
- High efficiency thanks to brushless motor
- Three selectable performance levels for torque screw tightening
Level 1: approx. 80 Nm at 700 rpm
Level 2: approx. 150 Nm at 1600 rpm
Level 3: approx. 220 Nm at 2500 rpm
- Amperage without load: 4.5 A
- Charging time ~ 35 min
- Belt clip included
- **Brushless DC motor (BLDC)**
– Longer service life, less wear, no need to change the carbon brushes
– High efficiency and hence less battery consumption
– More compact motor enables smaller dimensions
- **Contents:**
Cordless impact wrench, battery charger, Li-Ion battery 2.0 A (1x), high-quality carrying case

HAZET No.	■	Designation	□	max. Nm	max. Nm	kg With rechargeable battery	kg Without rechargeable battery	EAN-No. 4000896 +
9212 SPC-010	12 ⁵ 1/2	Basic unit, cordless impact wrench 18 V	1					214273
9212 SPC-1	12 ⁵ 1/2	3-piece set: 1 basic unit, 1 quick charger, 1 Li-ion rechargeable battery 2.0 Ah	3	200	260	1.45	1.06	212439
9212 SPC-1/4	12 ⁵ 1/2	4-piece set: 1 basic unit, 1 quick charger, 2 Li-ion rechargeable batteries 2.0 Ah	4					214259
9212 M-010	12 ⁵ 1/2	Basic unit, mini cordless impact wrench 18 V	1					214280
9212 M-1	12 ⁵ 1/2	3-piece set: 1 basic unit, 1 quick charger, 1 Li-ion rechargeable battery 2.0 Ah	3	220	270	1.34	0.95	212446
9212 M-1/4	12 ⁵ 1/2	4-piece set: 1 basic unit, 1 quick charger, 2 Li-ion rechargeable batteries 2.0 Ah	4					214266

Cordless impact wrenches



One rechargeable battery system for all devices!

700 Nm

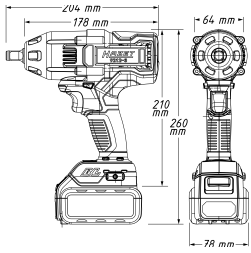

12.5 1/2

9212-3

Torque positions



State-of-charge display



3

1000 Nm



12.5 1/2

9212-1000

Torque positions



State-of-charge display

12.5 1/2 20 3/4

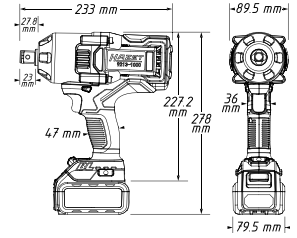

20 3/4

9213-1000



Including

Cordless impact wrench 18 V, 5.0 Ah

- Max. loosening torque: 700 Nm
- Max. tightening torque: 500 Nm
- High efficiency thanks to brushless motor
- 18 V, 5.0 Ah, Li-ion rechargeable battery
- Three selectable performance levels for torque screw tightening
 - Level 1: approx. 80 Nm at 600 rpm
 - Level 2: approx. 300 Nm at 1400 rpm
 - Level 3: approx. 500 Nm at 2000 rpm
- Amperage without load: 5,5 A
- Replacement battery: 9212-05
- Charging time at 5 Ah battery: approx. 80 min
- **Brushless DC motor (BLDC)**
 - Longer service life, less wear, no need to change the carbon brushes
 - High efficiency and hence less battery consumption
 - More compact motor enables smaller dimensions
- Loosening torque (max) determined with screw size M: 16
- Belt clip included
- **Contents:** Cordless impact wrench, battery charger, Li-ion rechargeable battery 5.0 A (1x), plastic case



Cordless impact wrench 18 V, 5.0 Ah

- Max. loosening torque: 1400 Nm
- Max. tightening torque: 1000 Nm
- High efficiency thanks to brushless motor
- Three selectable performance levels for torque screw tightening:
 - Level 1: approx. 180 Nm at 0 – 400 rpm
 - Level 2: approx. 400 Nm at 0 – 800 rpm
 - Level 3: approx. 1,000 Nm at 0 – 1,800 rpm
- Forward/reverse: multistage (left/right)
- Illumination of the work area before the output begins to move
- Robust machine housing
- Suitable for continuous operation
- Charging time at 5 Ah battery: approx. 80 min
- **Brushless DC motor (BLDC)**
 - Longer service life, less wear, no need to change the carbon brushes
 - High efficiency and hence less battery consumption
 - More compact motor enables smaller dimensions
- Loosening torque (max) determined with screw size M: 24
- Belt clip included
- **Contents:** Cordless impact wrench, battery charger, Li-ion rechargeable battery 5.0 A (1x), plastic case

HAZET No.	■	Designation	□	max. Nm	max. Nm	kg With rechargeable battery	kg Without rechargeable battery	EAN-No. 4000896 +
9212-3	12.5 1/2	3-piece set, contents: cordless impact wrench 18 V, 1 battery charger, 1 Li-ion rechargeable battery 5.0 Ah	3	500	700	2.5	1.86	203444
9212-1000	12.5 1/2	Basic unit, cordless impact wrench 18 V	1					222711
9212-1000/3	12.5 1/2	3-piece set: 1 basic unit, 1 quick charger, 1 Li-ion rechargeable battery 5.0 Ah	3			3.64	3.00	222674
9212-1000/4	12.5 1/2	4-piece set: 1 basic unit, 1 quick charger, 2 Li-ion rechargeable batteries 5.0 Ah	4					222681
9213-1000	20 3/4	Basic unit, cordless impact wrench 18 V	1	1,000	1,400			222698
9213-1000/3	20 3/4	3-piece set: 1 basic unit, 1 quick charger, 1 Li-ion rechargeable battery 5.0 Ah	3			3.70	3.04	222704
9213-1000/4	20 3/4	4-piece set: 1 basic unit, 1 quick charger, 2 Li-ion rechargeable batteries 5.0 Ah	4					222797



Video borescope with swivelling probe

- Full 180° swivel enables e.g. a real reverse view onto valves in the cylinder
- Camera head only 11 mm long (-50 % compared to conventional designs)
- Bending radius only approx. 35 mm (-30 % compared to conventional designs)
- Light boost and integrated reflection reduction
- Micro-lens: 4.5 mm Ø - Front view with a resolution of 640 x 480 pixel
- Casing made from steel mesh
- **Contents:**
 - 1 m probe cable with 4.5 mm Ø micro-lens and 5 dimmable LEDs
 - 1 operating panel
 - 1 SD card 4 GB
 - 4 x AA batteries

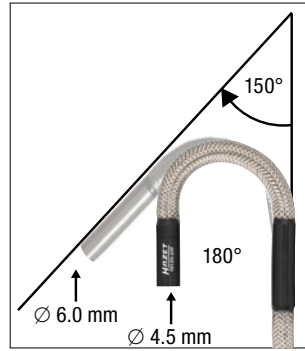

4812N-10/3AF
EAN-No. 4000896219131



Incl.

All in one!
Live video - recording - replay on TFT display!



Video borescope with Ø 4.9 mm switch probe

- **Contents:**
 - 1 m probe cable with 4.9 mm Ø micro lens and LED light sources
 - Operating panel
 - Hooks including magnet
 - SD card with 4 GB storage capacity
 - 4 x AA batteries

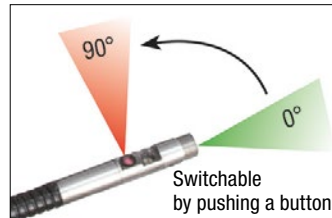

4812-10/4S
EAN-No. 4000896181742



4812-16



4812 N-1S



4812 N-1F



4812 N-5.5

Probes for video borescope

HAZET No.	Design	EAN-No. 4000896+	
4812-16	Ø 4.9 mm / 0° + 90°	181841	
4812 N-1 S	Ø 3.9 mm / 90°	187102	
4812 N-1 F	Ø 3.9 mm / 0°	187096	
4812 N-5.5	Ø 5.5 mm / 0°	187065	
4812 N-2 AF	Probe single: 1 m probe cable with Ø 4.5 mm micro-lens and LED light source	218868	



4812 N-2 AF



Pressure sprayer

- Capped pumping mechanism increases chemical resistance
- Viton® gaskets
- Integrated safety valve (2.5 bar)

Spraying with chemical and highly corrosive substances!



GERMAN DESIGN AWARD WINNER 2018



199 N-1
EAN-No. 4000896189007



Pressure foam sprayer

- Cleaning / disinfecting of surfaces, tools, vehicles, sanitary facilities
- For neutral cleaners as well as diluted acid and alkaline cleaners
- Integrated safety valve (2.5 bar)

Creating tight and permanent foam!



199-3
EAN-No. 4000896207237



195-3

Creeper/pneumatic chair

- Easy to clean

Quick and easy conversion from creeper to seat and vice versa



195-2

Mechanic's creeper

- Especially deep for maximum freedom of movement under the vehicle
- Rigid one-piece construction made of high strength plastic, black



195-4

Pneumatic chair

- Height-adjustable 380 – 510 mm
- 2 tool compartments
- Tilt-resistant
- Easy to clean



HAZET No.	Dimensions H x L x D mm	Loading capacity kg	kg	EAN-No. 4000896+
195-3	130 x 1198 x 450	150	10.4	148691
195-2	115 x 1030 x 480	130	5.8	125982
195-4	380–510 Adjustable in height	150	5.8	148707

Innovative wireless charging – charge by placing the device on top!



3
1979 W/3
 EAN-No. 4000896227969

LED light set, wireless charging

- Efficient and comfortable charging function due to optimised self-positioning of the light on the pad
- Charging starts immediately after the light is fitted
- 2-component plastic housing with rubberised surface
- **Contents:**
 1979 W-82 LED Pocket Light
 1979 W-91 LED Slim Light
 1979 WP-2 charging pad for 2 lights

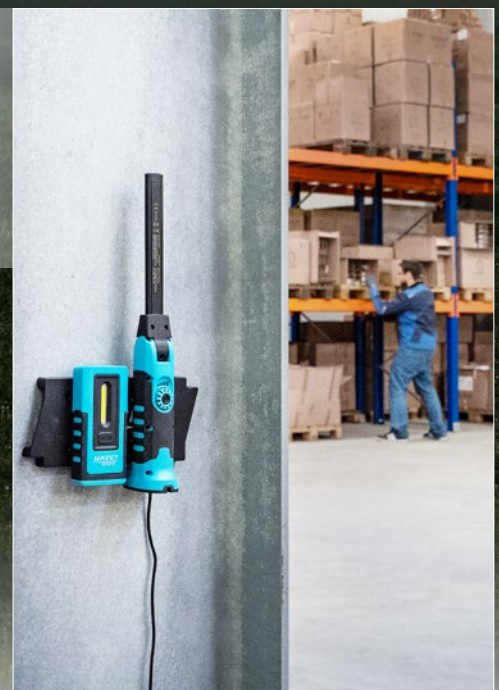

1979 W-82

LED Pocket Light, wireless charging

- Small design for use in areas with restricted access
- 180° adjustable and 8-step lockable base for adjustment of work area illumination



4-stage battery status and state-of-charge display

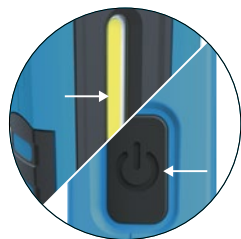

Main light progressively dimmable from 30 to 300 lumens



Top light/hook



Optimised self-positioning of the lights on the pad



1979 W-91

LED Slim Light, wireless charging

- For extremely tight application fields



Top light/
aluminium head piece

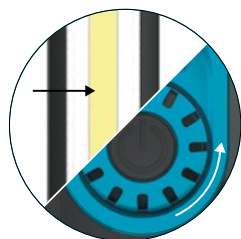

Main light progressively dimmable from 100 to 1000 lumens



4-stage battery and charging status display as well as dimmer switch on the back



Strong rubberised holding magnet at the bottom. 360° rotation retaining hook



HAZET No.	Operating time (h)	Luminous flux Lumen	Protection rating IP	Impact resistance	Charging time (h)		l mm	EAN-No. 4000896 +
1979 W-82	2 – 10	30 – 300	IP65	(EN62262): IK09	1.5	3.7 V 1200 mAh, rechargeable Li-ion battery pack	133	227228
1979 W-91	1.5 – 8	100 – 1000	IP65	(EN62262): IK08	3.5	3.7 V, 2600 mAh, rechargeable Li-ion battery pack	365	227938

1979 WP-1 / 1979 WP-2

Charging pad, wireless charging

- Optimised self-positioning of one/two light(s) on the pad

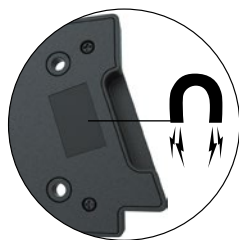

Holding magnets on the rear of the pad for fastening to magnetic substrates



Optionally possible to charge the battery either via pad or USB port



Incl. 4 screw holes



HAZET No.	Self-positioning on the pad	Designation	EAN-No. 4000896 +
1979 WP-1	For 1 light	For wireless charging of the LED lights HAZET 1979W-82 and 1979W-91. Delivery incl. 100 cm USB-C cable, without USB adapter	227952
1979 WP-2	For 2 lights		227945

LED lights

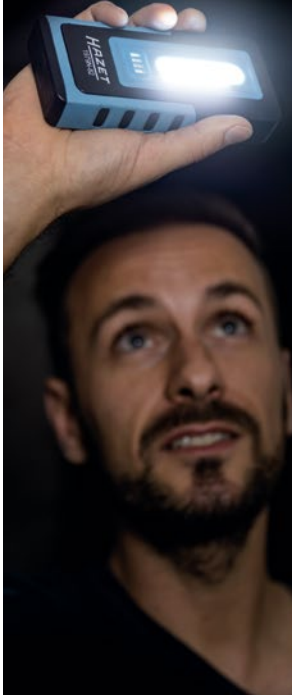

With charging cable

- Delivery incl. 100 cm USB-C charging cable, without USB adapter
- The battery can be charged via a standard USB adapter, 5 V max. 1 A
- Power supply via USB C port



1979 N-82

LED Pocket Light



1979-91

LED Slim Light



1979 N-71

LED penlight



1979 N-72

LED torch light



HAZET No.	Impact resistance	Operating time (h)	Protection rating IP	Luminous flux Lumen		l mm	EAN-No. 4000896 +
1979 N-82	(EN62262): IK09	1.5	IP65	30 – 300	3.7 V 1200 mAh, rechargeable Li-ion battery pack	133	227211
1979-91	(EN62262): IK07	3.5	IP65	100 – 1000	3.7 V 2600 mAh, rechargeable Li-ion battery pack	365	222452
1979 N-71	(EN62262): IK07	4.0	IP45	130	2 x AAA-1.5 V batteries (incl.)	139	208470
1979 N-72	(EN62262): IK07	4.0	IP45	200	3 x AAA-1.5 V batteries (incl.)	135	208487

LED work spotlight

- Ideal work / construction spotlight for renovations, painting work or car repairs, for example
- Robust PU housing with surrounding aluminium components for better heat dissipation
- Visual power indication: 4-stage
- Base: 90° adjustable
- Extendable by:
 - 1979 F-01 light diffuser
 - 1979 F-02 holding magnet
 - 1979 F-03 telescopic tripod



1979 FC-40

1979 FC-60



Optionally with 40 or 60 Watts!



- Increased functionality by an additional 230V socket on back enables coupling and operation of additional devices
- Rotatable dimmer switch for infinite adjustment/power indication
- Impact and fall-proof, impact resistance: IK07
- Base: 90° adjustable

HAZET No.	Uniform room lighting	Cable length	Luminous flux Lumen	Protection rating	Watts	230 V Socket	l mm	EAN-No. 4000896 +
1979 FC-40	Energy-efficient COB LED technology	5 m (H07RN) 3 x 1.5 mm ²	400 – 4000	IP54	40	1x	280	227839
1979 FC-60	Energy-efficient SMD LED technology		600 – 6000		60	2x	360	227822

HAZET No.	Designation	EAN-No. 4000896 +
1979 F-01	Light diffuser for better and homogeneous room illumination and for 360° light diffusion	227815
1979 F-02	Magnet holder, maximum retention force: 10 kg	227808
1979 F-03	Telescopic tripod. Tripod permits a secure stand on different surfaces	227174



1987 N-3
Genuine leather working gloves



1987 N-4
Working gloves with micro-foam coating



1987-5
Mechanic's gloves



1987-6
Mechanic's gloves

HAZET No.	Material	Size	EAN-No. 4000896 +
1987 N-3	High-quality mix of materials from genuine leather and modern microfibre textiles	One size	222650
1987 N-4	60% cotton, 40% polyester	One size	203840
1987-5 L	48% polyamide/nylon, 25% polyacrylic, 25% polyester, 2% polyurethane	L	181735
1987-5 XL	48% polyamide/nylon, 25% polyacrylic, 25% polyester, 2% polyurethane	XL	181759
1987-5 XXL	48% polyamide/nylon, 25% polyacrylic, 25% polyester, 2% polyurethane	XXL	181766
1987-6	The palm has a high-quality nitrile rubber coating	One size	222643



Made in Germany

196 N-1
Universal fender cover

- Magnetic fastening (6 magnets)
- Suitable for nearly all vehicle types



196-2
Fender cover

- Made of specially coated anti-slip material
- Adheres almost completely vertically to all car body surfaces (aluminium, steel, GRP)



196-6/2
Steering wheel and seat cover set

- One size fits all
- Antistatic



4852/4
Dashboard protection with handle

- Angled (270 x 200 mm, 450 x 300 mm) and straight (270 x 200 mm, 450 x 300 mm)



Made in Germany

195-1
Kneeling mat

- Easy-to-clean surface

195-5
Mechanic's mat

- Easy-to-clean surface



9070-10
Magnetic holder

- Loading capacity: 10 kg

197-3
Magnetic cup

- With magnet for fixing
- Ø 150 mm



1977-2/4
Telescopic inspection mirror set

- Double hinge with tension spring



HAZET No.	Function	EAN-No. 4000896 +
196 N-1	Protection from scratches, dents, oil and dirt, W 960 x H 670 mm	208258
196-2	Adheres almost completely vertically to all car body surfaces (aluminium, steel, GRP), W 980 x H 500 mm	149469
196-6/2	Reusable, durable	150151
4852/4	For protection against damage to the dashboard, interior lining and vehicle headlining when removing windows	210114
195-1	Kneeling mat 30 x 450 x 210 mm (HxWxD)	121069
195-5	Mechanic's mat (not shown), 30 x 975 x 385 mm (HxWxD)	153718
9070-10	With two strong magnets to hold: 1 impact wrench, 4 sockets and 1 torque wrench	158157
197-3	Holds small parts such as screws etc.	158584
1977-2/4	Telescopic rod, extension length: 300 - 740 mm, round mirror: Ø 30 / 50 mm, round mirror, rectangular mirror: 65 x 43 mm	150144

Impact socket set (6-point)

- With plastic insert to protect the surface of the wheel bolts

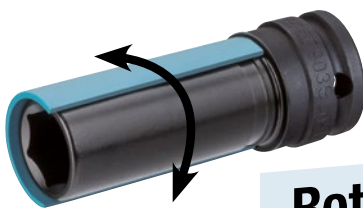

Rotating!



Made in Germany



903 SLg

Made in Germany

12S 1/2

HAZET No.	S mm	l mm	EAN-No. 4000896+
903 SLg-15	15	85	072231
903 SLg-17**	17	85	045822
903 SLg-19	19	85	045839
903 SLg-21	21	85	055135
903 SLg-22	22	85	155453

**17: optimised contours for deeper rim hole in e.g. AUDI S-Line, AMG, OZ etc.

Sets

- Three sockets each in a practical storage box

3



Made in Germany

HAZET No.	S mm	l mm	EAN-No. 4000896+
903 SLg-17/3	17	85	191697
903 SLg-19/3	19	85	191734

- Three sizes in one set

12S 1/2



Made in Germany

HAZET No.	S mm	l mm	EAN-No. 4000896+
903 SPC/3	17, 19, 21	85	128754

Extra long style

- Especially for wheel mounting and dismounting on AMG-rims and/or alloy rims with deeply located wheel bolts



904 SLg-17

Made in Germany

HAZET No.	S mm	l mm	EAN-No. 4000896+
904 SLg-17	17	130	100576
904 SLg-19	19	130	203710
904 SLg-21	21	130	227006

- Particularly suitable for wheel mounting and removal on SUVs e.g. PORSCHE Cayenne, Macan; AUDI Q7, Q5; VW Touareg

12S 1/2

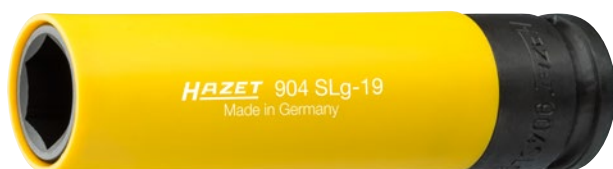

904 SLg-19

- Particularly for wheel mounting and dismounting with aluminium rims on HYUNDAI, KIA, TOYOTA, MAZDA



904 SLg-21

Special profile

- Especially for wheel mounting and dismounting of light-alloy rims for hybrid wheel bolts in all new MERCEDES-BENZ vehicles
- For e.g. MERCEDES-BENZ C Class type 204, 204X, E Class type 211, 212, 207; SLK type 172; M Class type 164, 166; S Class type 221, 222, CL Class type 216

- With borehole for locking pin or safety spring and groove for o-ring Wheel nuts with special profile s 21 mm on HYUNDAI i30, Tucson and KIA
- Applications include HYUNDAI i30, Tucson and KIA

12S 1/2



905 SLg-17

Made in Germany

HAZET No.	S mm	l mm	EAN-No. 4000896+
905 SLg-17	17	86	198795
905 SLg-21	21	86	201624



905 SLg-21



One power adapter, many possibilities!

For loosening 1/2" bolted joints with 3/4" power!

For all sockets with outside hexagon 24



1/2" S 24 mm

24

20 3/4"

20 3/4"

24

Take, for example, our 3/4" impact wrench 9013 M and connect our adapter 1003 S-1 to the square. At the other end, put one of our sockets with outside hexagon connection.

Adapter ① with borehole for locking pin ② or safety spring and groove for o-ring ③



Set 903 SLg6/5



Made in Germany

Made in Germany
903 SLg 6/5
EAN-No. 4000896223602

HAZET No.			S mm	l mm		EAN-No. 4000896+
903 SLg6-17	125 1/2		17	85	1	223596
903 SLg6-19	125 1/2		19	85	1	223589



Wheel hub grinder

- Prevents incorrect wheel bolt tightening torque caused by corrosion
- Quick and easy removal of rust and dirt from contact surfaces of wheel hubs and brake discs with wheel bolt support
- Wear-resistant: approx. 100 vehicles per wheel
- Open-pored abrasive material and cup-formed grinding wheel reduce the formation of dust to a minimum
- No formation of sparks



Before

After



- 11 mm outside hexagon with 3 contact surfaces for attachment e.g. to pneumatic, cordless and corded drilling machines
- **Contents (4-piece set):**
1 base component, 3 grinding wheels \varnothing 160 mm
- Spare grinding wheels: 4960 R-0160/3

3

- Spare grinding wheels: 4960 R-0160/3

4960 R-160/4



HAZET No.	\varnothing Inside mm	\varnothing rpm	\varnothing Passenger car wheel hub mm	EAN-No. 4000896+
4960 R-160/4	75	500	160	218820
4960 V-160/2	75	500	160	218394
4960 F-160/2	50	500	160	218387

Spare parts

HAZET No.	Designation	\varnothing mm	■	EAN-No. 4000896+
4960 R-0160/3	With hook and loop fastener	160	3	218790
4960 V-0160/3				218813
4960 F-0160/3				218806



- With $\frac{1}{2}$ inside square collet for attachment e.g. to pneumatic, cordless and corded impact wrenches
- **Contents (2-piece set):**
1 base component, 1 grinding wheel \varnothing 160 mm
- Spare grinding wheels: 4960 V-0160/3

2

- Spare grinding wheels: 4960 V-0160/3

4960 V-160/2



Rim flange cleaner

2

- For optimum cleaning of the contact surface on the rim inside
- 11 mm outside hexagon with 3 contact surfaces for attachment e.g. to pneumatic, cordless and corded drilling machines
- With centre hole guidance and integrated sander for cleaning the wheel centring
- For wheel centring diameter: min. 51 mm
- **Contents (2-piece set):**
1 base component, 1 grinding wheel \varnothing 160 mm
- Spare grinding wheels: 4960 F-0160/3

4960 F-160/2



\varnothing 160 mm

3

Wheel hub grinder set for passenger cars

- Base component made of aluminium with 8-point profile enables safe and firm attachment of the grinding wheels
- With hexagon insert for firm hold at the device
- For wheel hubs with stud bolts (diameter of grinding zone 40 or 50 mm), e.g. **FORD, PORSCHE, Volvo**, Japanese passenger cars
- Wear-resistant: approx. 50 vehicles per wheel
- **Contents (12-piece set):**
 1 base component made of aluminium
 6 grinding wheels \varnothing 50 mm
 5 grinding wheels \varnothing 40 mm



4960 N-45/12
 EAN-No. 4000896186860

Spare grinding wheels

HAZET No.	Designation	\varnothing mm		EAN-No. 4000896 +
4960 N-50/5	With hook and loop fastener	50	5	187126
4960 N-40/5		40		187232

Tyre inflators



9041-1

Standard

- Handle with operating lever and discharge knob, hose with integrated plug-in nipple



9041 D-1

Digital

- Optimal readability even in poor light conditions
- Hose with plug-in nipple
- Handle with integrated suspension hook
- Display toggles between bar / PSI / Kg/cm²
- Manometer can be turned



9041 G-1

Calibrated

- Calibrated device with optimally readable, large manometer
- Hose with plug-in nipple
- Handle with integrated suspension hook



HAZET No.	bar	Hose Length mm	Manometer measuring range bar	Graduation mm	\varnothing Manometer mm	kg	EAN-No. 4000896 +
9041-1	8	400	0 – 12	0.1	63	0.411	147076
9041 D-1	12	400	0 – 12	0.01	63	0.385	212378
9041 G-1	10	1000	0 – 10	0.1	80	0.585	212385

Henn® clamp tool

- Universally in use for proper operation of Henn clamps on cooling water and charging air hoses
- **Handle shift enables operation even on Henn clamps that are difficult to access**
- Length: 100 mm
- Width: 20 mm (in the functional range)



Handle can be shifted by 90°



Made in Germany

4562-1

EAN-No. 4000896222353



Pipe stopper set, 4 pieces

4

- Very quick closure of pipes prevents liquids from escaping
- For sealing pipelines in brake systems, air conditioning systems, power steering and fuel systems that cannot be secured with a flexible hose clamp
- For single sealing in sizes of 6.3 mm (1/4") · 8 mm (5/16") · 10 mm (3/8") and for double sealing (e.g. banjo connections) in size 10 mm (3/8")



4591/4

EAN-No. 4000896219650



Universal injector extraction tool set

8

- Enables the removal of the injectors without removing the electrical connector or injector head
- Advantage: without any previous injector defect, reinstallation is possible without recalibration
- Universal set for removing diesel injectors on the brands **Bosch, Delphi, Siemens, Denso** using a sliding hammer

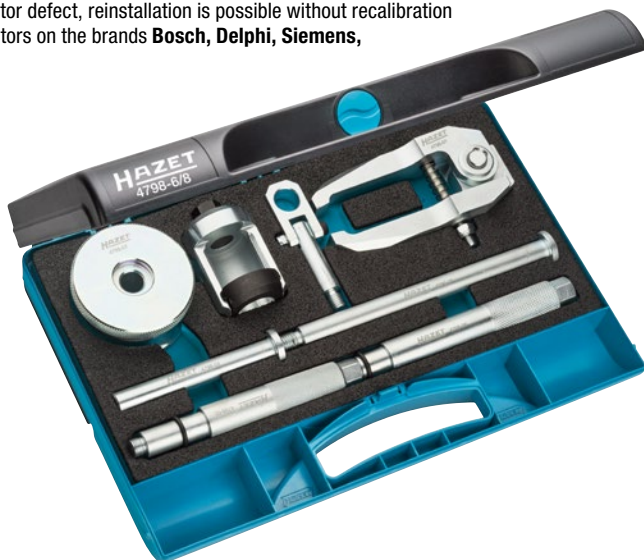

Incl. special adapter!

4798-6/8

EAN-No. 4000896210763



1/3			
-----	--	--	--



Injector removal tool set MERCEDES-BENZ (Bosch / Delphi), 12 t

8

- Huge time savings since the engine does not have to be removed to disassemble the injectors
- The 12 t hydraulic cylinder enables simplified loosening of very tight injectors
- For **MERCEDES-BENZ** 2.1 I, 2.2 I, 3.0 I V6 (CDI 2.1 I, 2.2 I **Delphi**, CDI 3.0 I V6 Bosch), Vito, CLK, Sprinter, Viano, Vario as well as M, GL, C, GLK, E, CLS, S, R, G-Class, **CHRYSLER** 3.0 I V6
- Operation of hydraulic cylinders using e.g. HAZET 600N-19



Approx. 6 hours of time saving possible!

4798-8/8

EAN-No. 4000896210749



1/3			
-----	--	--	--



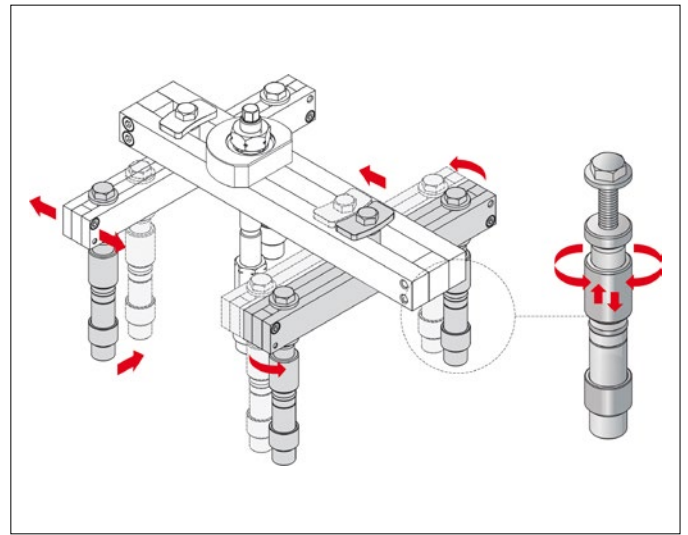

Universal injector removal tool set, mechanical with Bosch adapter

- Huge time savings since neither cylinder head nor engine have to be removed
- Especially for disassembling very tight injectors
- Heavy duty supporting bridge can be individually adapted to the space available and supporting options on the cylinder head
- Feed shaft M18 and thrust bearing ensure high tractive power
- Including adapter for **Bosch** solenoid valve injectors
- Removal of **Siemens**, **Denso** and **Delphi** injectors using the optionally available accessories

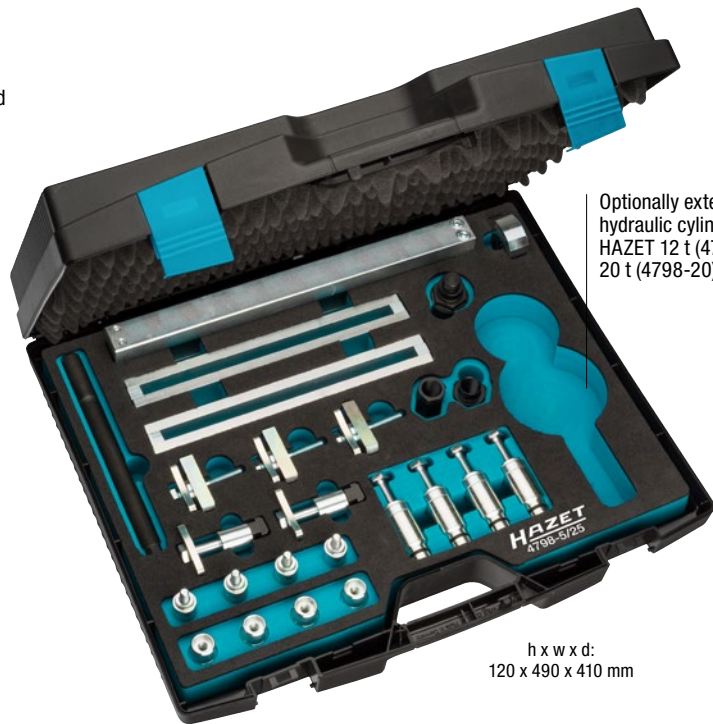

Optionally extendable with hydraulic cylinder, e.g. HAZET 12 t (4798-9/6) or 20 t (4798-20)



4798-5/25

EAN-No. 4000896210688

h x w x d:
120 x 490 x 410 mm

Accessories, injector sockets

	HAZET No.	Designation	■	S mm	EAN-No. 4000896 +
①	4798-13	Bosch		29	210527
②	4798-14	Bosch		30	210633
②	4798-15	Siemens		25	210640
②	4798-16	Siemens		27	210657
②	4798-17	Bosch		28	210664
③	4798-18	Special screwdriver socket for solenoid valve screw connection		10	210695



Accessories, adapter

	HAZET No.	Designation	■	EAN-No. 4000896 +
④	4798-10/3	Injector adapter set Denso		210725
⑤	4798-11/5	Injector extractor set, Bosch		210671
⑥	4798-12/13	Injector extractor set, RENAULT		210701
⑦	4798-21/2	Injector adapter set, Siemens		210770
⑧	4798-22	Adapter plate, RENAULT		210510



Disassembly / assembly auxiliary tool

- For securely holding **glow and spark plugs**
- Prevents the glow and spark plugs from falling down and becoming damaged during disassembly/assembly
- Auxiliary tool for screwing and unscrewing glow and spark plugs, especially in constricted spaces
- Full rubber design
- Length of 230 mm enables more careful threading and unthreading



4760-11

EAN-No. 4000896222346

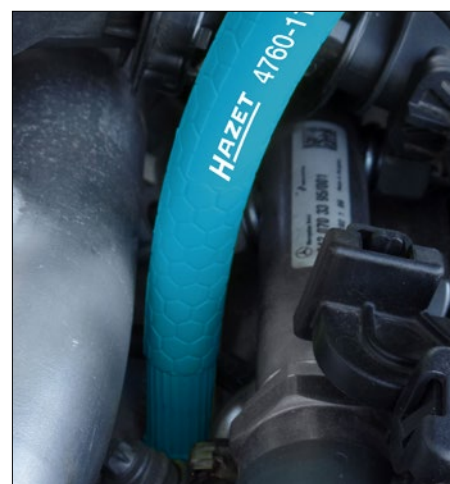

Oil filter wrench

- For the operation of oil filters and oil filter housing caps
- For operation of the oil filter in **FORD** models e.g. with EcoBoost engines incl. B-Max; C-Max 2; Fiesta 5-6-7; Focus 2-3; Fusion; Galaxy; Mondeo 4-5; Tourneo; Transit, Ka+; Kuga 2; S-Max **MAZDA** 2 (DL, DJ) 1,5D; 3 (BK, BL) 2,0 (BM, BN) 1,5D - 2,2D (BP) 1,8D; 5 (CW) 1,8-2,0; 6 (GG) 1,8-2,0 (GY, GH) 1,8-2,0-2,5 (GJ, GL) 2,2D; CX-3 (DK) 1,5D-1,8D; CX-5 (KE, GH, KF) 2,2D; CX-7 (ER) 2,3D-2,5D; MX-5 (NC) 1,8-2,0
- 15-point
- s 74 mm

Made in Germany

2169-8A

EAN-No. 4000896232956



NEW!

125 1/2

Oil filter wrench

- Operation of a Purflux oil filter with \varnothing 76 mm and 12 grooves
- With protective coating
- For e.g. **AUDI, CITROËN, DACIA, FIAT, FORD, MERCEDES-BENZ, NISSAN, PEUGEOT, RENAULT, HONDA, OPEL/VAUXHALL, SUZUKI, VW, SEAT, ŠKODA**
- On various **RENAULT** engines, e.g. K9K engines, the oil filter is located very close to the alternator or starter motor.
Danger: A short circuit can occur here when using a standard oil filter wrench
- Safe application by non-conductive surface coating of the HAZET oil filter wrench
- Eye-catching coating colour reduces the risk of it being left in the engine compartment after operation
- With protective coating
- Outside hexagon 24 mm / s 76 mm groove profile (6 grooves)

Made in Germany

2169-76B

EAN-No. 4000896230259



NEW!

125 1/2

TORX® articulated wrench socket

- Disassembly of the gearbox holder: time saving approx. 20 minutes
- Much better accessibility of the screw connection on EGR valve and cooler enables further time saving approx. 15 minutes
- For operating the oil pan screw connection in the engine and automatic gearbox and for removing the EGR cooler, EGR valve, valve cover etc. in **MERCEDES-BENZ** etc. in the OM 651 engine
- Use and extension permanently connected
- Total length: 150 mm

Made in Germany

850 LG-GE10

EAN-No. 4000896223572



E 10

6.3 1/4

Fuel filter releasing tool

- Can be used easily even in areas with restricted access
- For operating the fuel filter housing when changing the fuel filter cartridge on **FORD** Duratorq 2.2 TDCI engines, Transit Custom since 04/2012 →, Tourneo Custom since 04/2012 →, Transit since 08/2013 →
- Output: groove profile
- Length: 130 mm
- Outside Ø: 160 mm

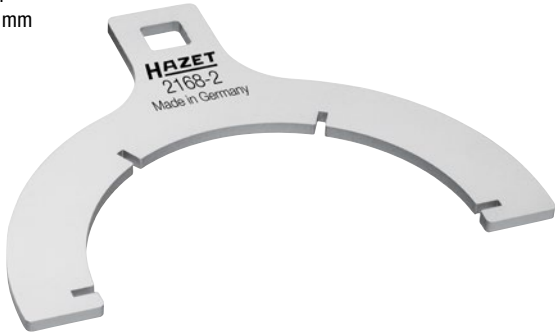

Made in Germany
2168-2
EAN-No. 4000896226870

125 1/2

FORD socket for plastic oil drain plug

- Perfectly designed for plastic oil drain plugs
- Prevents damage resulting from the use of e.g. unsuitable extraction tools
- Special socket for operating the plastic oil drain plug for e.g. **CITROËN** C4, C5, Spacetourer, Jumpy, DS4, DS5 with 2.0 Blue HDi engine since 09.2013 →; **FORD** Mondeo, S-Max, Kuga, Galaxy, Focus, C-Max with 2.0 TDCi engine since 09.2014 →; **FORD** (USA) Edge with 2.0 TDCi engine since 08.2015 →; **FORD** (Australia) Kuga, Escape, Mondeo with 2.0 TDCi engine since 09.2014 →; **OPEL/VAUXHALL** Grandland X 2.0 D since 11.2017 →; **PEUGEOT** 308, 508, 3008, 5008, Expert, Traveller with 2.0 Blue HDi engine since 11.2013 →; **TOYOTA** Proace Verso, bus, box, platform with 2.0 D engine since 02.2016 →; **OPEL/VAUXHALL** Grandland X 2.0 D since 10.2017 →
- Length: 32 mm



Made in Germany
3420-1
EAN-No. 4000896224159

Multifunctional drain pans

- For oil change / oil filter replacement and for cleaning of parts



- Resistant to acid and alkaline solutions
- From TÜV-certified production in accordance with DIN ISO 16901



HAZET No.	Contents l	Dimensions (L x W x H)	EAN-No. 4000896+
197 N-1	6	400 x 390 x 120 mm	198924
197-2	16	600 x 450 x 180 mm	146802

Made in Germany

HAZET No.	Contents l	Internal dimensions (W x D x H)	EAN-No. 4000896+
197-50	50	800 x 520 x 100 mm	210008

Hook set

- Securely hanging dismantled components, e.g. brake callipers, avoids damage to brake hoses, lines etc.
- Universal application
- Surface dip-insulated
- Length: 190 mm
- Hook-Ø: 7 mm



4968/2H
EAN-No. 4000896221820

TRUCK/CV SPECIAL 2020



Das Werkzeug



Christina Scheib

Sascha Lenz

Püppi@Work

Kim Johann Tiefnig

Jule Hanke

ARE YOU FAMILIAR WITH OUR
NEW BROCHURE TRUCK / CV SPECIAL 2020?



Universal brake tool set

- All important tools for professional brake disassembly/assembly as well as for cleaning with direct access
- Revised set contents adapted to today's needs



1x		4968-6
1x		4968-2
4x		751KHS-3 · 751KHS-4 748LGB-3 · 748LGB-4
1x		810U-PH3
1x		10 3/8 s 7 8801K-7
1x		12 1/2 s 11 986LG-11
1x		10 3/8 s 11 2784-1
1x		10 3/8 s 8 2584-8
1x		10 3/8 s 7 2901G-7
1x		12 1/2 s 9 986-9
1x		12 1/2 s 9 986LG-9



1/3				
-----	--	--	--	--

14

163-548/14
EAN-No. 4000896224197

Brake calliper screwdriver socket

- Problem-free operation of the brake calliper fitting
- Brake calliper screw connection on: e.g. **MERCEDES-BENZ** ML-Class, Type 166, model years 2011 →, **FORD** Mondeo model years 2014 →, C-Max, S-Max and Galaxy model years 2015 →

12 5/8 s 11 **TIN**



Made in Germany

986 Lg-11

EAN-No. 4000896216536

l_1 mm	l_2 mm	d_2 mm
60	98	23

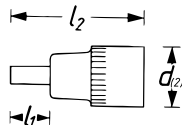

12 5/8



Square brake calliper file

- Extra slim design
- For easy removal of stubborn brake dust, rust and dirt from the brake calliper



Made in Germany

4968-6

EAN-No. 4000896218431

l_1 mm	l_2 mm
155	265

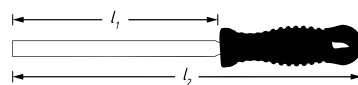

Brake line scraper

- Curved design enables work even in cramped and hard-to-reach areas
- For removing dirt, underbody protection and rust from brake lines and for locating concealed corrosion areas
- Application is possible with pulling or pushing
- Replaceable blade
- For brake line \varnothing 4.75 mm

Made in Germany

4968-12

EAN-No. 4000896219964

l mm
245



Made in Germany

HAZET No.	Designation	EAN-No.	
4968-012	Replacement blade for brake line scraper 4968-12	229871	



NEW!

NEW!

Brake fluid tester

- For checking the brake fluid
- Portable, can be used everywhere – to be connected to battery, replaces a stationary installation
- Can be used as a boiling point tester with a higher testing accuracy in comparison to other testing methods
- Easy application: in most vehicles, brake fluid remains in its fluid reservoir
- Time saving - the test can be carried out directly in the fluid reservoir
- Security for the user – no fluid loss (environmentally sound)
- Accepted by vehicle manufacturers
- Approved by TÜV Austria
- For DOT 3 · DOT 4 · DOT 4+ · DOT 5 · DOT 5+ brake fluid
- Easy application using one pushbutton
- No brake fluid selection necessary
- Warning in case of too low operating voltage
- Cable length: 2.20 m
- Operating voltage: 12 V
- Temperature range: 320° C / 608° F
- Measurement duration: approx. 30 sec.
- Test container and syringe included in delivery
- Checks in °C and °F possible



4954-2
EAN-No. 4000896229628

Calliper gauge for brake discs / thickness gauge

- Measurement without wheel removal
- Effortless measurement on the vehicle in the course of direct receptions in the presence of the customer
- **Measuring range: 0 – 60 mm** (also suitable for application on commercial vehicles)
- Easy to handle
- **Note:** Information on the wear limits – Please observe vehicle manufacturer's data!
- Length: 395 mm



4956-3
EAN-No. 4000896219032



Calliper gauge for brake discs (diameter)

- Simple, quick determination of the brake disc diameter through wheel opening without removing the wheels
- For determining the brake disc diameter through rim openings
- **Measuring range: 200–400 mm**

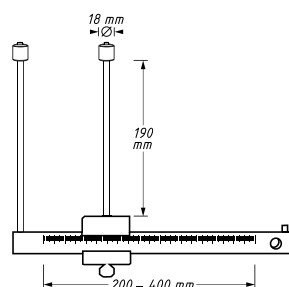

4956-4
EAN-No. 4000896222339

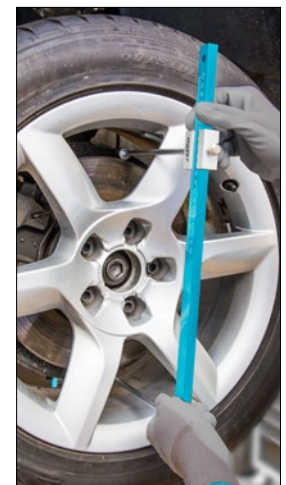
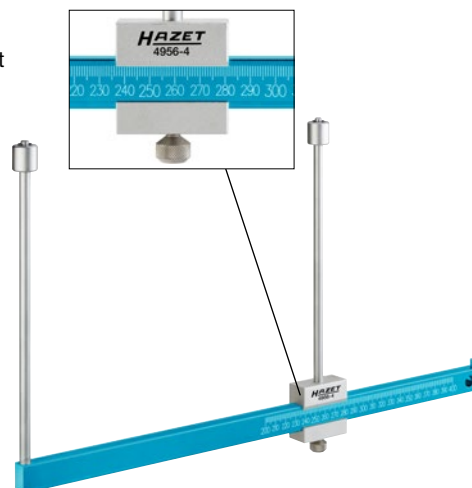

Hand riveting tool with rotating rivet head

- For riveting various materials such as metal, aluminium, plastic, leather, etc.
- Flexible application due to 360° rotary head
- Incl. 4 replaceable nose pieces, practically stored in the body of the pliers
- With easy to store assembly tool in the handle
- Incl. patented rivet plug gauge
- Suitable for aluminium, steel and stainless steel blind rivets

NEW!

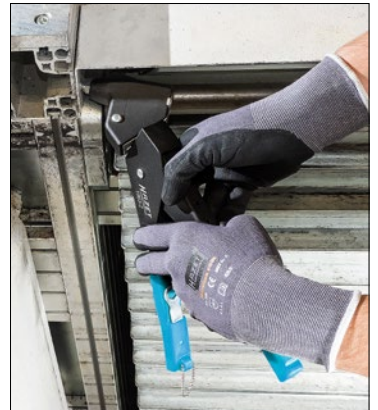

1963-2

EAN-No. 4000896232864



l mm
290

Flat nose pliers for grab handles and sun visors VAG

- For adjusting interior grab handles and sun visors of the VAG Group
- Universal application as flat nose pliers or adjusting pliers as well
- Handles with dip coating
- Application in car bodies or for other removal/assembly work
- For easily unlocking vehicle-specific retainer clips

NEW!

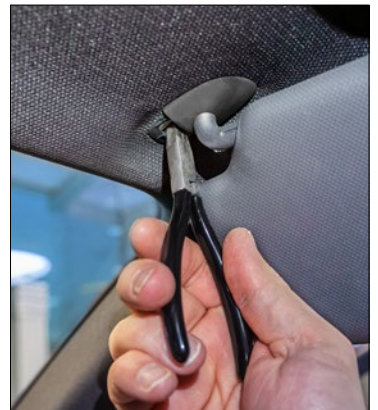

Made in Germany

1816K-1

EAN-No. 4000896232949



kg	l mm
0.08	135

Headlight adjustment tool, hexagon screwdriver, extra long

- Time saving: putting together different tools is not necessary. Screwdriver length ensures problem-free operation of the setting screws
- Extra long hexagon screwdriver for adjusting the headlights on **RENAULT, AUDI**, among others
- 6-point blade

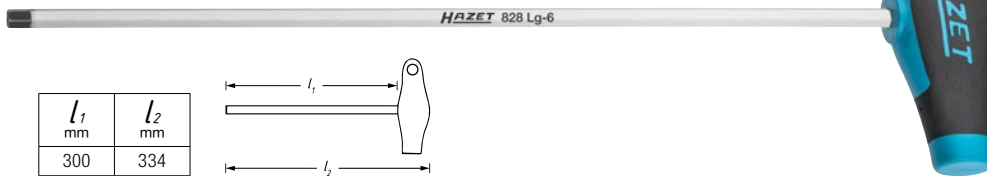

828 Lg-6

EAN-No. 4000896226672

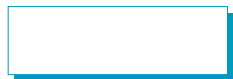

l_1 mm	l_2 mm
300	334

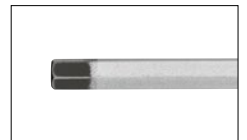
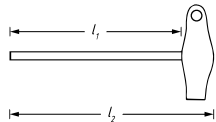

Clamp washer operating tool

- For operating the clamp washers on underfloor panels and heat shields on e.g. **AUDI, SEAT, ŠKODA, VW, FORD**
- Length: 22 mm
- Operating range \varnothing : 27 mm

6.3 1/4

Universal hook/wedge set

2

- For loosening components such as e.g. door clips as well as for lifting and alignment work, window rubber, door seals, carpets, interior trim
- Plastic wedge: length: 214 mm, width: 26.5 mm
- Universal hook: length: 180 mm

Made in Germany

2534-1

EAN-No. 4000896224227



1965/2

EAN-No. 4000896223008

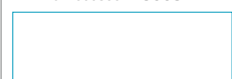

IN PARTNERSHIP WITH



Drive shaft disassembly / assembly set

- For disconnecting the drive shaft joint and pulling in the shaft through the wheel hub with just one tool
- Disconnecting the drive shaft joint from the shaft using the sleeves or spindles in conjunction with e.g. HAZET sliding hammer 4797-1 (not included)
- Pulling in the drive shaft through the wheel hub on vehicles where the drive shaft is very difficult to pull through the wheel hub
- Suitable for all vehicle brands
- For drive shafts with outside and inside thread

Contents:

- 2 spindles (M14, M16) to pull the drive shaft through the wheel hub or separate the joint from the drive shaft when the joint has an inside thread
- 2 sleeves to support it on the wheel hub
- 1 spindle nut
- 7 screw sleeve adapters
 - M16 x 1.5 (VAG, MAZDA)
 - M18 x 1.5 (Volvo, SUZUKI, OPEL/VAUXHALL)
 - M20 x 1.5 (MERCEDES-BENZ, VAG, MITSUBISHI, MAZDA)
 - M22 x 1.5 (FIAT, PSA, BMW, FORD, OPEL/VAUXHALL, HYUNDAI)
 - M24 x 1.5 (RENAULT, BMW, MERCEDES-BENZ, OPEL/VAUXHALL, MAZDA, HONDA, VAG)
 - M27 x 1.5 (PSA, BMW, FORD)
 - M30 x 1.5 (MERCEDES-BENZ, PSA, BMW)



Made in Germany

4935-11/12

EAN-No. 4000896217434

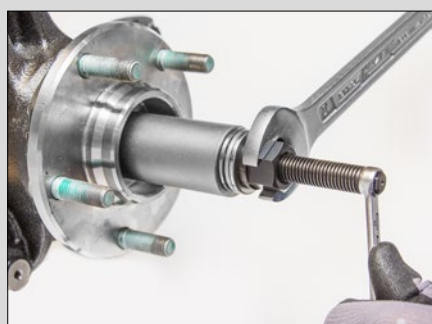

Sliding hammer

- M 16 x 1.5
- Striking weight: 1.8 kg
- Length: 460 mm



Made in Germany

4797-1

EAN-No. 4000896121175

Clamp pliers

Made in Germany

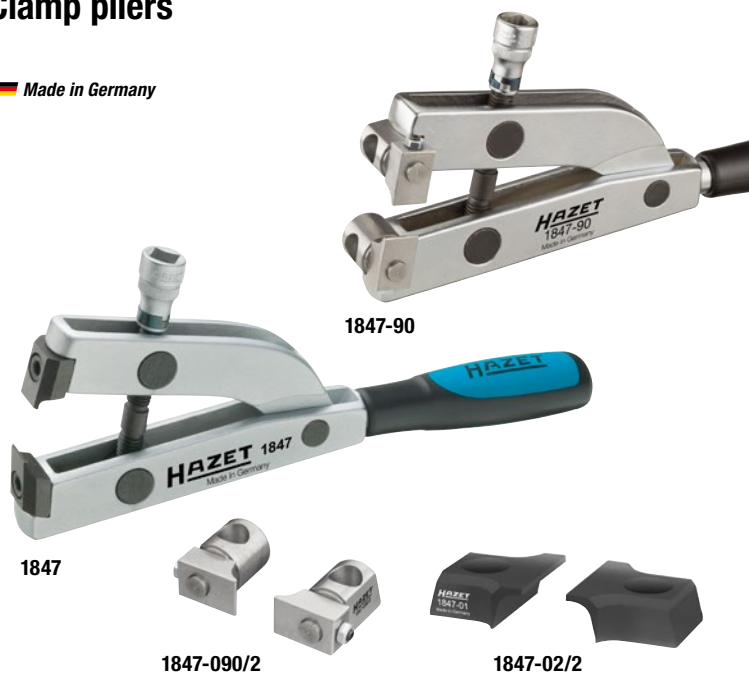

1847

1847-90

1847-090/2

1847-02/2

IN PARTNERSHIP WITH



15

Circlip pliers set

- Easier, damage-free assembly of the drive shaft joint: Damage to the serration of joint and shaft is avoided with internal circlip during assembly of the drive shaft joint
- Correct, centred insertion of the circlip when mounting the joint on the drive shaft
- Easy fixing of the locking pliers over the circlip without damaging the bellows
- The pliers automatically slip down when striking the joint
- Suitable for drive shafts from all manufacturers
- No other tools needed
- **Contents:**
 - 1 circlip pliers 1847-12
 - 7 pairs of half shells in graduated diameter sizes:
 - Half shells \varnothing : 19 · 21.4 · 22.3–23 · 23.8–24.6 · 26.2–26.9 · 28.5–29.2 · 30 mm



Made in Germany

1847-12/15

EAN-No. 4000896221288



Application tip:

- Insert appropriate half shells in pliers depending on shaft diameter
- Place pliers on serration with pre-assembled circlip and clamp
- Pre-positioning of the joint due to conical shape of the pliers makes it easier to introduce the serration without damage

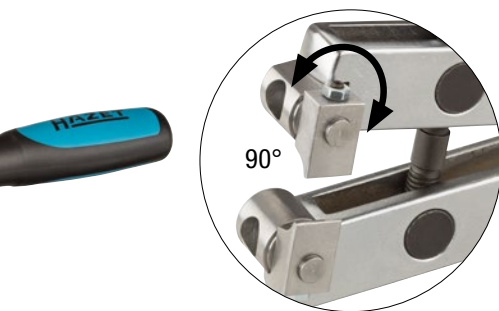

Made in Germany

HAZET No.	Description	Application / mounting	EAN-No. 4000896 +
1847	Clamp pliers for axle boots	For installing axle boots made of Hytrel and bands made of special stainless steel with pre-set torque values, in conjunction with e.g. torque wrench HAZET 5110-3CT / 6110-1 CT	050918
1847-90	Clamp pliers for axle boots 90°, angled	Collet chuck 90° for activating stainless steel bands with specified torque tightening values	206728

Set

3

1847/3	Clamp pliers for axle boots 1847 with replaceable jaws 90° (1847-090/2)	206902
--------	---	--------

Accessories

1847-090/2	Pair of clamping jaws, angled 90°	Pair of clamping jaws 90° for difficult to access stainless steel bands	206711
1847-02/2	Pair of clamping jaws	Pair of clamping jaws for steering gear boots AUDI A4 / A5 / A6 / A7 / Q5	174447

Double cone wheel bearing tool set

- For unscrewing e.g. screwed wheel bearings in combination with HAZET sliding hammer 1969-17. Can be used for almost all wheel bearings
- In soft foam insert

Contents:

- 1 x spindle, total length: 305 mm
- Outside thread TR20 x 3
- Inside thread M20 x 1.5
- 2 x spindle nut TR20 x 3
- 2 x lock nut TR20 x 3
- 6 x cone



11



Made in Germany

4933-1/11

EAN-No. 4000896223022

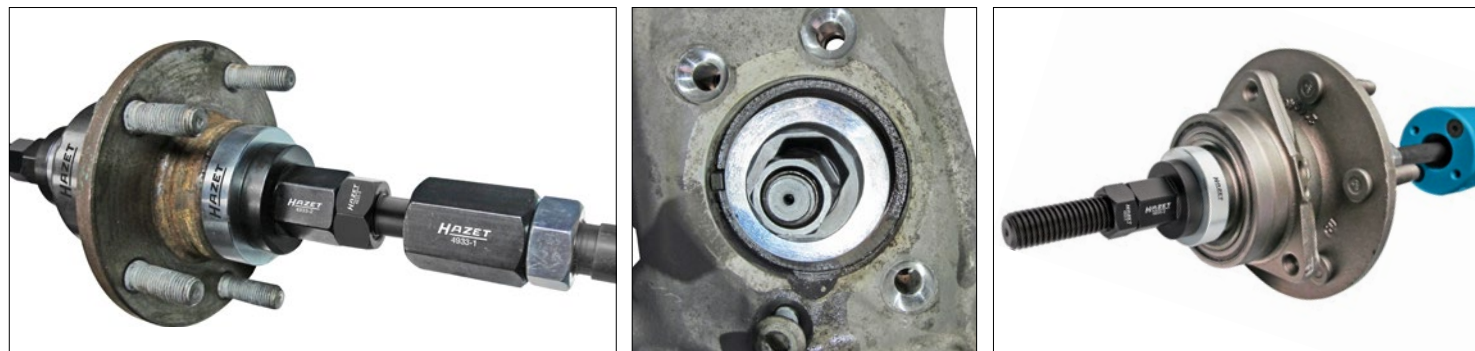

Sliding hammer

- Striking weight: 6 kg
- Coupler thread: M20 x 1.5
- Total length: 890 mm



1969-17

EAN-No. 4000896223015

BMW inside spring vice set

- Installation and removal of the coil spring on the rear axle
- Optimally coordinated to the confined spaces in the following vehicles

BMW

- 1-series E87 hatchback model years 2003 → 2011
- E81 hatchback model years 2006 → 2013
- E82 coupé 2006 → 2014
- E88 convertible model years 2007 → 2015
- X1 E84 model years 2009 - 2015
- 3-series E90 notchback model years 2004 → 2012
- E91 touring model years 2004 → 2013
- E92 coupé model years 2005 → 2013
- E93 convertible model years 2005 → 2013

- Pendulum 6-point head for uniform distribution of power
- With integrated anti-twist protection
- Internal guidance of the tensioning jaws prevents spring from sliding out
- Both-sided spindle operation possible
- Plastic box with soft foam insert

Contents:

- Inside spring vice 4902-1
- Tensioning jaw 4902-10, -11
- Tubular box wrench 4902-210, -224
- Reversible ratchet s 21 mm 4910-1



6

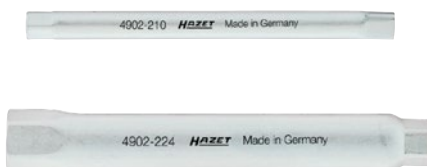
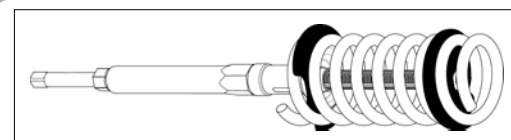

Made in Germany

4902/6

EAN-No. 4000896121694

Chassis

 Made in Germany



AUDI inside spring vice set

- Internal guidance of the tensioning jaws prevents spring from sliding out
- For disassembly and assembly of the coil springs on the rear axle (standard chassis)

AUDI

A4 B8 8K2 (Limousine 09/2008 → 04/2015)

A4 B8 8K5 (Avant 08/2009 → 04/2015)

A5 8T (Coupe 06/2007 → 06/2016, Sportsback 09/2009 → 10/2016)

A5 8F (convertible 03/2009 → 11/2016)

A6 C7 (Limousine 05/2011 → 08/2016)

A6 C7 (Avant 05/2011 → 08/2016)

- Pendulum 6-point head provides a uniform distribution of power with the integrated twist protection
- Both-sided counterholder of the spindle possible
- Plastic box with foam inlay

Contents:

- 1 inside spring vice 4902-4
- 1 tensioning jaw 4902-28
- 1 tensioning jaw 4902-29
- 1 tubular box wrench 4902-224, s 24 mm



NEW!

A5 8T
A5 8F
A6 C7

For standard chassis of all stated models!



Application tip:

- Easy handling for just one user
- Removal of surrounding components and time-consuming extra work is no longer necessary for spring disassembly:
 - No axle components need to be removed
 - Axle alignment no longer necessary
 - Disassembly and assembly possible in just 6 minutes on each side

Conclusion: Tremendous time saving!



 Made in Germany

4902/4

EAN-No. 4000896219308

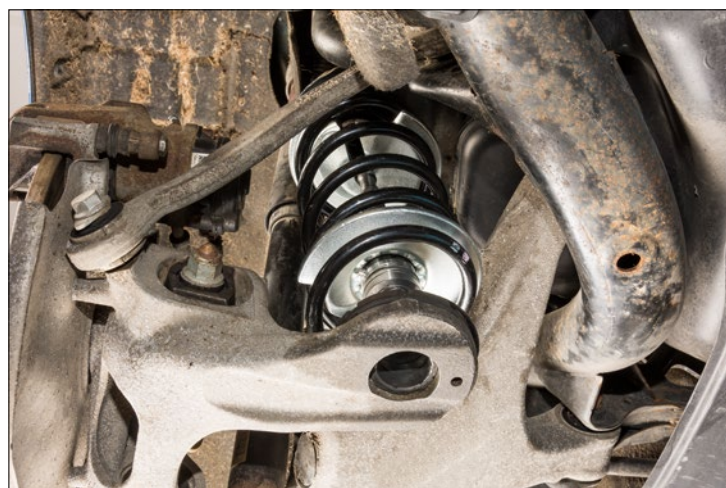

Stationary universal spring vice

4

New seating and assembly concept

- Swivelling in horizontal or vertical working position
- HAZET recommendation for ergonomic working height: adjust vertically, operate horizontally
- Damage to shock absorbers and head plates impossible (no overload risk)
- Simple, lockable strut mount

High safety

- Consistently reliable mounting of head plates
- Thread damage to piston rod impossible
- Permanent fixation of spring throughout operation

Secure investment by using existing components of SYSTEM 4900

- Existing basic units 4900-2 A and all tensioning jaws of System 4900 may be used
- Use of future applications is assured

Allows record keeping by scaling

- If recurring, significant time savings by scaling
- Firm fixation eliminates readjustment at the same spring strut (left / right)

Can be used for almost any spring strut / shock absorber

Load-free disassembly / assembly with completely relieved shock absorber

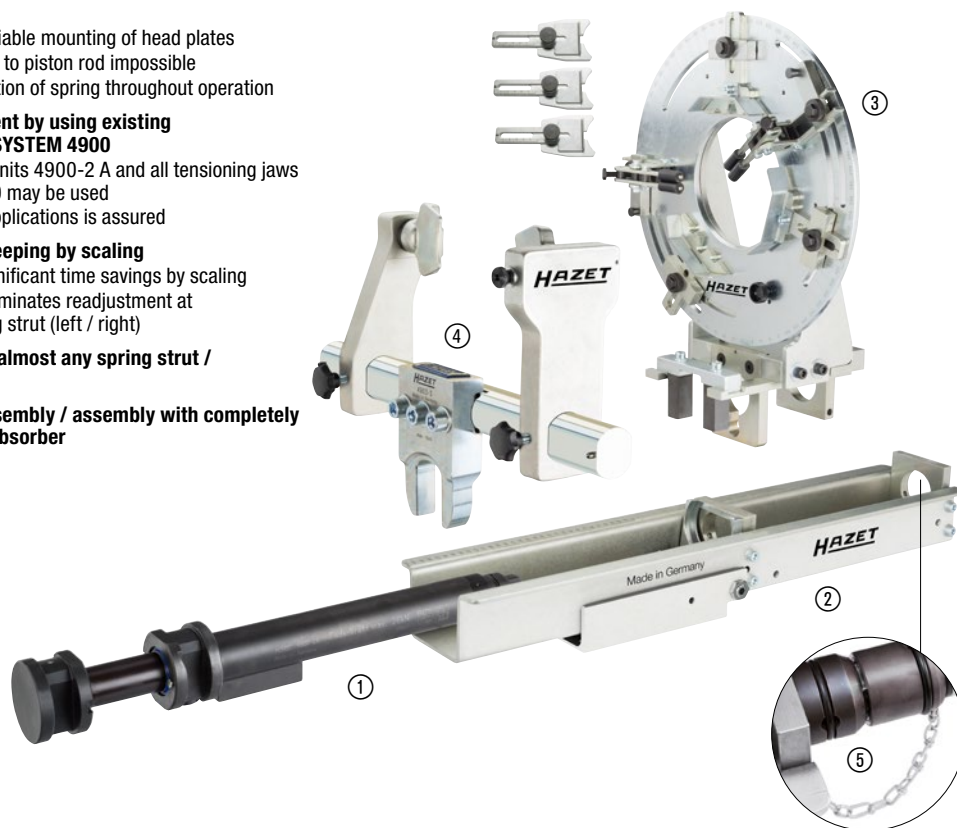

Safety spring vice 4903/4



Application video 4903/4



Made in Germany

4903/4

EAN-No. 4000896180561

- ① 4900-2 A safety spring adapter ⑤
- ② 4903-1 basic support
- ③ 4903-2 clamping disc (adjustable)
- ④ 4903-3 tensioning jaw (adjustable)

HAZET No.	Description	□	EAN-No. 4000896 +
4903-1	②	1	179824
4903/2	③ ④	2	180530
4903/2 A	② ⑤ ①	2	180547
4903/3	② ⑤ ③ ④	3	180554
4903/4	① ② ③ ④ ⑤	4	180561

Application video 4903/4 W 203



Safety spring vice set

5

- Suitable for impact wrenches
- Closed system – maintenance-free
- Variable system thanks to easily replaceable tensioning jaws
- With socket rail for machinist's vice
- No further special tool necessary
- Suitable for approx. 100 different vehicle types

Contents:

- 1 basic unit 4900-2A
- 4 tensioning jaws each 2 x 4900-11 and 4900-12



Further information:



Made in Germany

4900-2 A/5

EAN-No. 4000896086054



Chassis

 Made in Germany

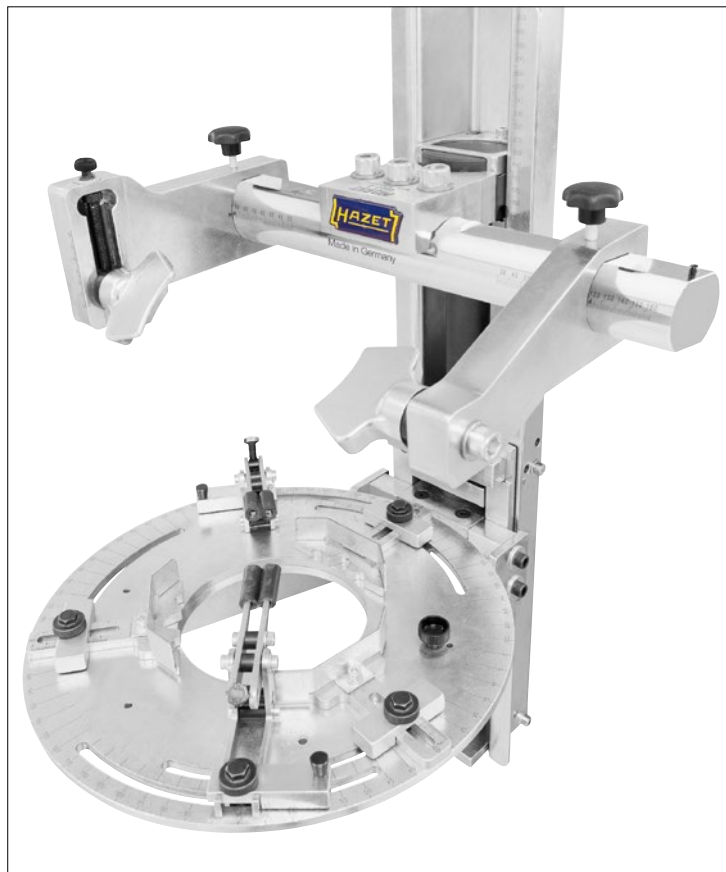
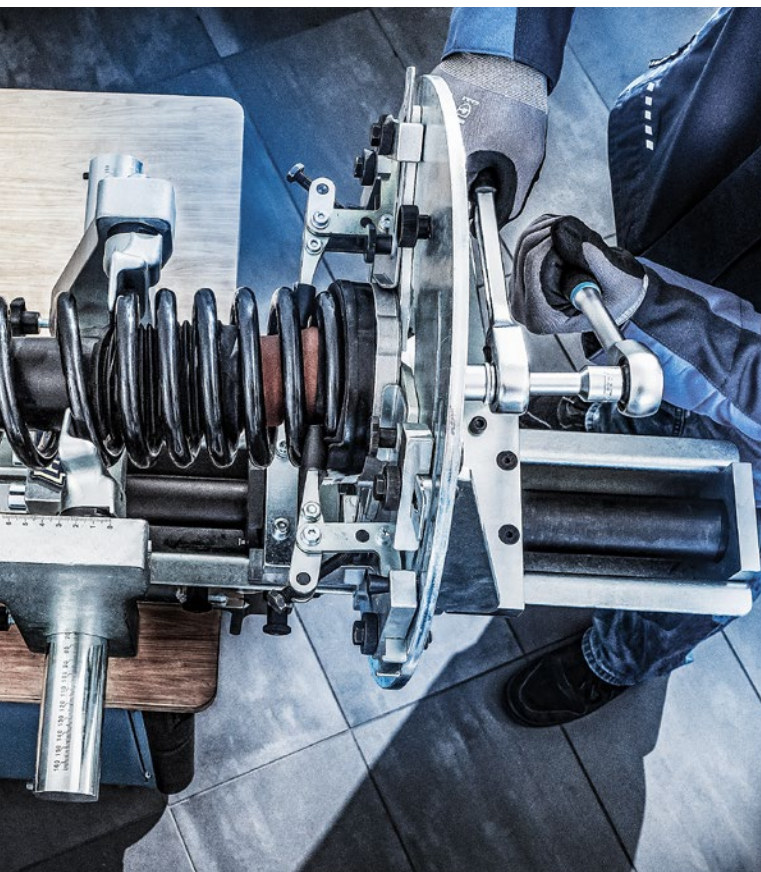

Spring strut fixation

Swivelling

Optimum working height approx. 1.30 m

Operating

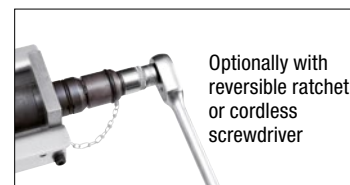
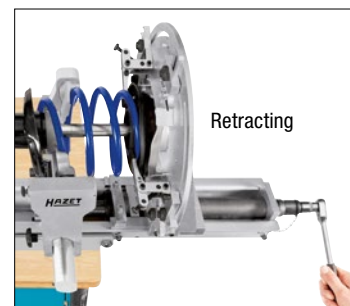
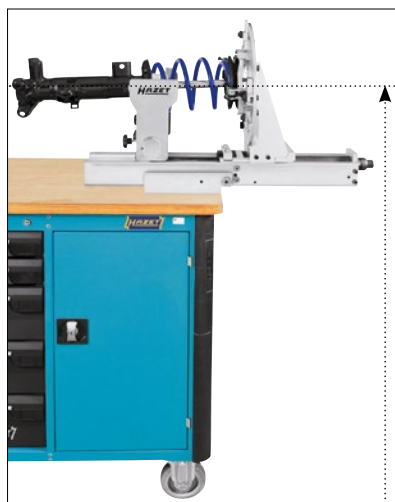

Spreader for wheel bearing housing

 12.5 1/2

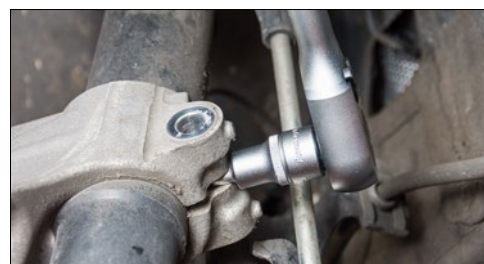

 Made in Germany

HAZET No.	Application		EAN-No. 4000896+
4912-1	Application e.g. in VW Fox model years 2005 →, Polo model years 2002 →, New Beetle, Golf model years 1998 to 2004, Tiguan model years 2008 →, Eos model years 2006 →, Passat model years 2006 →, Touran model years 2003 →, Caddy model years 2004 →, T5 model years 2004 → AUDI A2 model years 2001 →, A3 model years 2004 →, A4 model years 2001 to 2008, A5 model years 2008 →, A6 model years 2008 →, TT model years 2007 → SEAT, ŠKODA	5.5 x 8 mm	156368
4912-2	Application on e.g. RENAULT, PEUGEOT, CITROËN	5 x 7 mm	155804
4912-3	Application e.g. for BMW · MINI	6 x 8 mm	217427
4912-4	For extending spring strut and supporting joint supports (for disconnecting the spring strut from the wheel bearing housing), e.g. on MERCEDES-BENZ Sprinter, Type 910 with front wheel drive since 2018	7.8 x 11 mm	222551



Tool trolley 179 N XL-8/321 with 321 expert tools!

NEW!



179 N XL-8
Made in Germany
959 x 518 x 1020 mm

179 NXL-8/321
EAN-No. 4000896224395

321

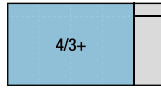

163-549/160

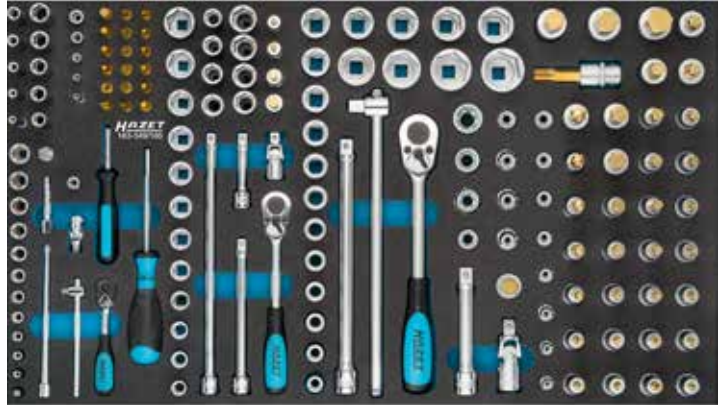

163-478/40



163-480/57



163-479/26



163-522x50

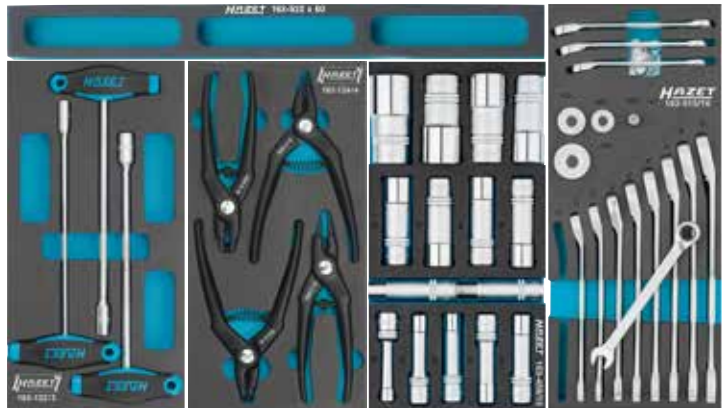

163-122/3

163-124/4

163-459/15

163-515/16

Your HAZET specialist dealer

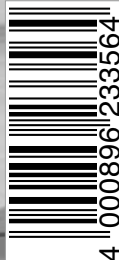

4 000896 233564



Assistant